

INSTALLATION AND OPERATION MANUAL  
FOR SUPERTRACK MODEL S8  
Ku-BAND TV-RO ANTENNAS



**KNS Inc.**

Tel)+82-42-932-0351~2

Fax)+82-42-932-0353

Web) <http://kns-kr.com/>



05.17. 2010



KNS SuperTrack systems are manufactured in the Republic of South Korea.

**CE 0678** 

The KA-70 Antenna Control Unit complied with the ETSI (European Telecommunications Standards Institute) Standards; EN 301 843, EN 60950 and EN 302 340 (2006-04) as of November 24, 2009.

#### Copyright Notice

All Rights Reserved. The information contained in this document is proprietary to KNS, Inc. This document may not be reproduced or distributed in any form without the consent of KNS, Inc. The information in this document is subject to change without notice.

Copyright 2010 KNS, Inc.

## Revision History

Revision	Date	Description	By	Remarks
1.0	02.22. 2010	Initial Release (PCU Ver. 1.95 & ACU Ver. E1.12)	Hong	
1.1	05.17. 2010	Update text and figures about changed ACU software (PCU Ver. 1.96 & ACU Ver. E1.20)	Hong	

# Contents

<b>1. Introduction .....</b>	<b>1</b>
1.1. Purpose .....	1
<b>2. Installation .....</b>	<b>2</b>
2.1. Site Selection .....	2
2.2. Unpacking the Unit.....	4
2.3. Equipment and Cable Installation.....	5
2.4. Antenna Unit Mounting .....	6
2.5. ACU Mounting.....	9
2.6. Gyro Connection .....	10
2.7. Cable Connection .....	13
<b>3. Operation .....</b>	<b>21</b>
3.1. Front Panel Functions.....	21
3.2. ACU Display Operation .....	24
3.3. Set-up Mode .....	26
<b>4. How to Operate the SCS .....</b>	<b>37</b>
4.1. Connect to PC.....	37
4.2. Selection Area and Satellite .....	39
4.3. Skew Setting .....	43
4.4. Antenna State .....	45
4.5. Installer.....	48
<b>Appendix A: Example of Setting the Satellite's Parameters Using SCS .....</b>	<b>61</b>
<b>Appendix B: Error Code Definition .....</b>	<b>66</b>
<b>Appendix C: Specifications.....</b>	<b>69</b>
<b>Appendix D: Satellite Information .....</b>	<b>70</b>
<b>Appendix E: Radome and Antenna Mounting Holes Layout .....</b>	<b>75</b>

# 1. Introduction

## 1.1. Purpose

The purpose of this manual is to provide the necessary information required by the end user, customer and installer to successfully install the S8 antenna and controller and to program the KA-70 for operation.

It is recommended that all personnel responsible for operating S8 systems should know which type of system they have, read and understand the basic terms, and be familiar with the operation of these systems.

Although installations may be completed by the customer's preferred personnel, it is also recommended that personnel be trained in the KNS suite of equipment installation procedures and trained by the relevant KNS Inc. experts.

## 2. Installation

### 2.1. Site Selection

Determine the optimum mounting location for the antenna radome assembly. It should be installed where:

1. The antenna has a clear line-of-sight view of as much of the sky as is practical. Choose a location where masts or other structures do not block the satellite signal from the dish as the boat turns.
2. The antenna is situated at least 5m away from other transmitting antennae (HF, VHF and radar) that may generate signals that may interfere with the SuperTrack S series antenna. The further away the SuperTrack S series antenna is from other such antennae, the less impact their operation will have on it.

The antenna radome assembly should be rigidly mounted on the boat. If necessary, reinforce the mounting area to ensure that it does not flex due to the boat's motion or vibration.



Figure 2-1 *Best Location I*



Figure 2-2 *Best Location II*

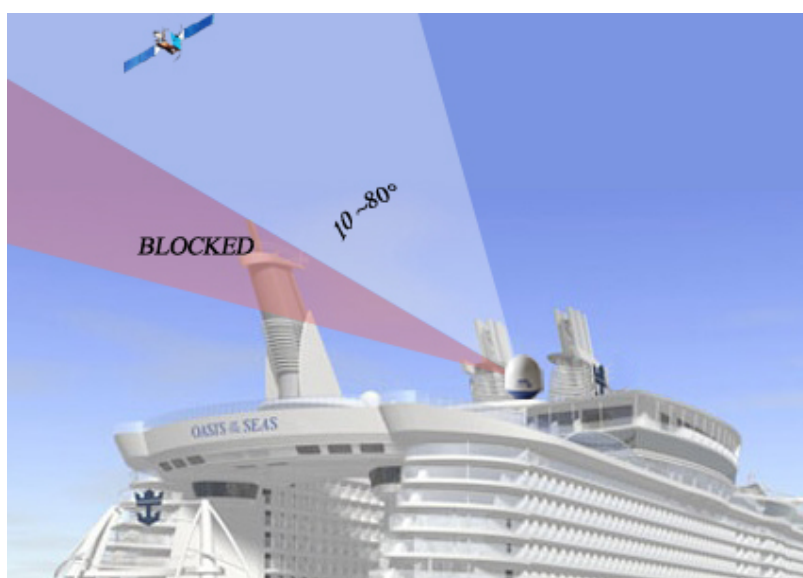

Figure 2-3 *Antenna Blockages*

## 2.2. Unpacking the Unit

Open the wooden box using pliers and remove the items of antenna equipment. Do not turn the box on its side to tip or roll out the product, or turn the box upside down to remove it.



**Figure 2-4 Unpack the Antenna**



## 2.3. Equipment and Cable Installation

The coax connector bracket beneath the radome is labeled. The functional assignment of these labels is as follows:

S8 Connectors

RF1: Connect to the multi-switch (Vertical Low).

RF2: Connect to the multi-switch (Horizontal Low).

RF3: Connect to the multi-switch (Vertical High).

RF4: Connect to the multi-switch (Horizontal High).

ACU: Connect to the ACU.

**NOTE:** The RF4 coax connection must be plugged into the 18VDC port of your multi-switch. This must be the horizontal high band input of your four-ports Multi-switch when using a Quattro LNB.

**NOTE:** Unused coax connections (on the connector bracket) **MUST** be terminated with a 75ohm terminator.

**NOTE:** We recommend the following cable types for cable lengths:

-within 20m: RG6

-within 50m: RG11

-within 100m: LMR400

-within 200m: LMR600

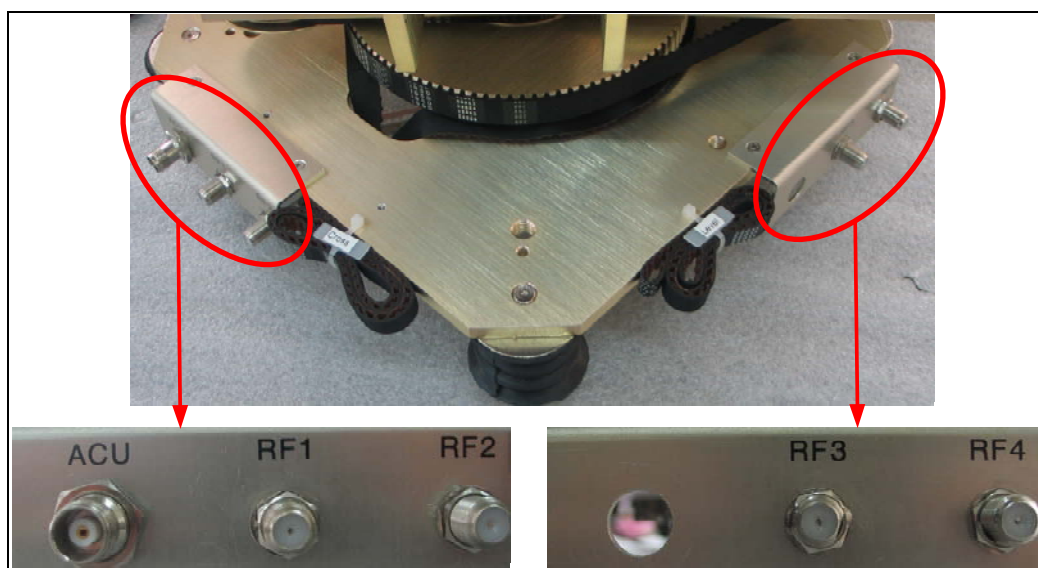

Figure 2-5 RF Connector Bracket

## 2.4. Antenna Unit Mounting

Drill four bolt holes and cut out a cable access hole on the mounting site. (See reference appendix.)

Position the foam seal on the mounting surface with the hole centered over the cable access cut-out.

Position the base plate over the mounting holes and the cable access hole, and then align the radome base plate's "Bow" label (shown in Figure 2-6) with the ship's bow.

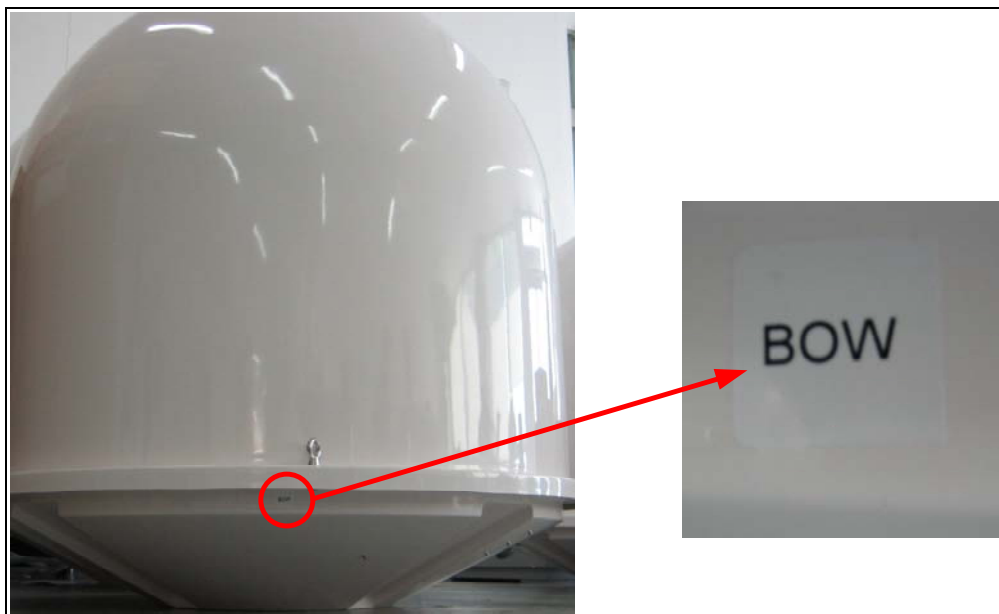

**Figure 2-6 "BOW" Label of the Radome Base**

1. Connect the data/power and the RF cables from below decks to the base plate with a 7/16" wrench, applying 30 pounds of torque. Check the label on both ends of each RF cable to match its antenna base-plate connector. Do NOT use Teflon gel on the cable fittings as it reduces signal strength at high frequencies.
2. Install flat washers and spring washers and a mounting bolt to each mounting hole of the radome base from the underside of the mounting surface. Apply Loctite 241 to the threads of the mounting bolt up near the mounting surface and tighten each of the 4 bolts to 24 in-lb (21 kg-cm) of torque [finger tight, then about 1/4 turn tighter] with a wrench. DO NOT OVER-TIGHTEN. You have to install mounting bolts of the proper length. If a bolt is too long, the extra length of threaded rod that extends above the radome base should be cut off.

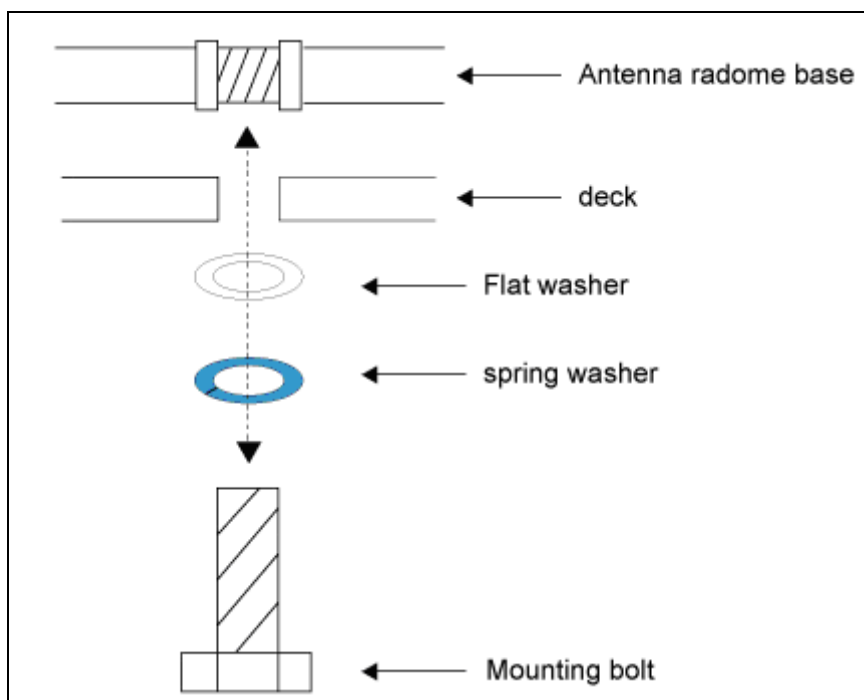

**Figure 2-7 Tighten the nuts from below**

3. Remove the jigs and wire ties holding the Antenna. Please refer to Figures 2-8 and 2-9 below.

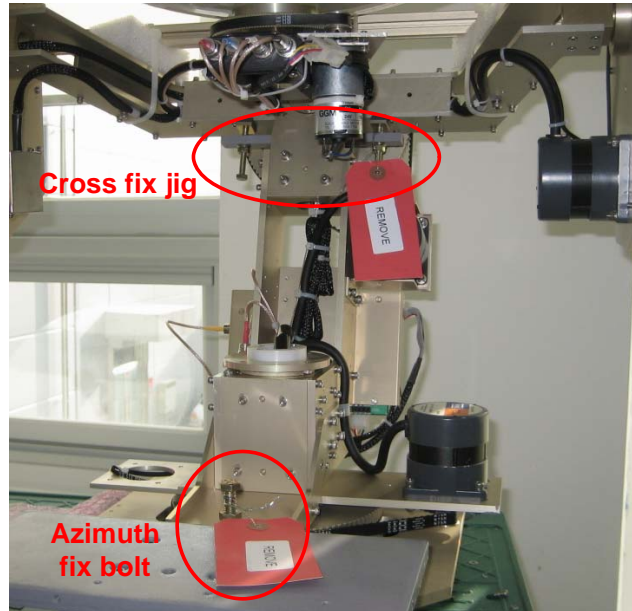

Figure 2-8 *Cross & Azimuth Fix Jig 1*

**Elevation fix tie**



Figure 2-9 *Elevation Fix Tie*

## 2.5. ACU Mounting

The ACU may be mounted either horizontally or vertically.

1. The ACU should be placed in a dry location that is convenient for the user.
2. It must be situated in a place that is not susceptible to magnetic interference; nor must it be situated on a level surface.
3. It should be placed so that the LCD display is visible and the buttons are easily accessible.

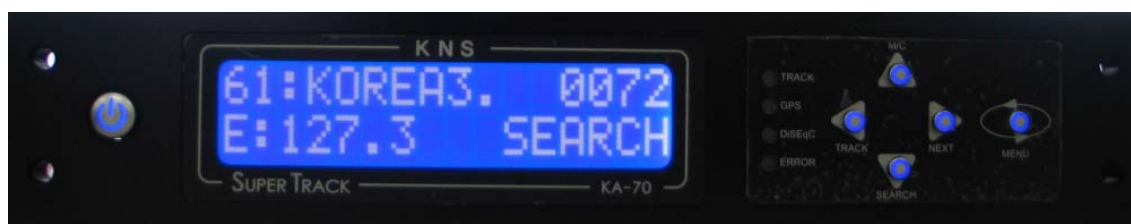

Figure 2-10 KA-70 ACU

## 2.6. Gyro Connection

The SuperTrack S8 receives NMEA-type gyro signals when the compass mode is 'Gyro'. Connect the NMEA port of the ACU back panel with a ship's gyro using a 9-pin connector (female type).

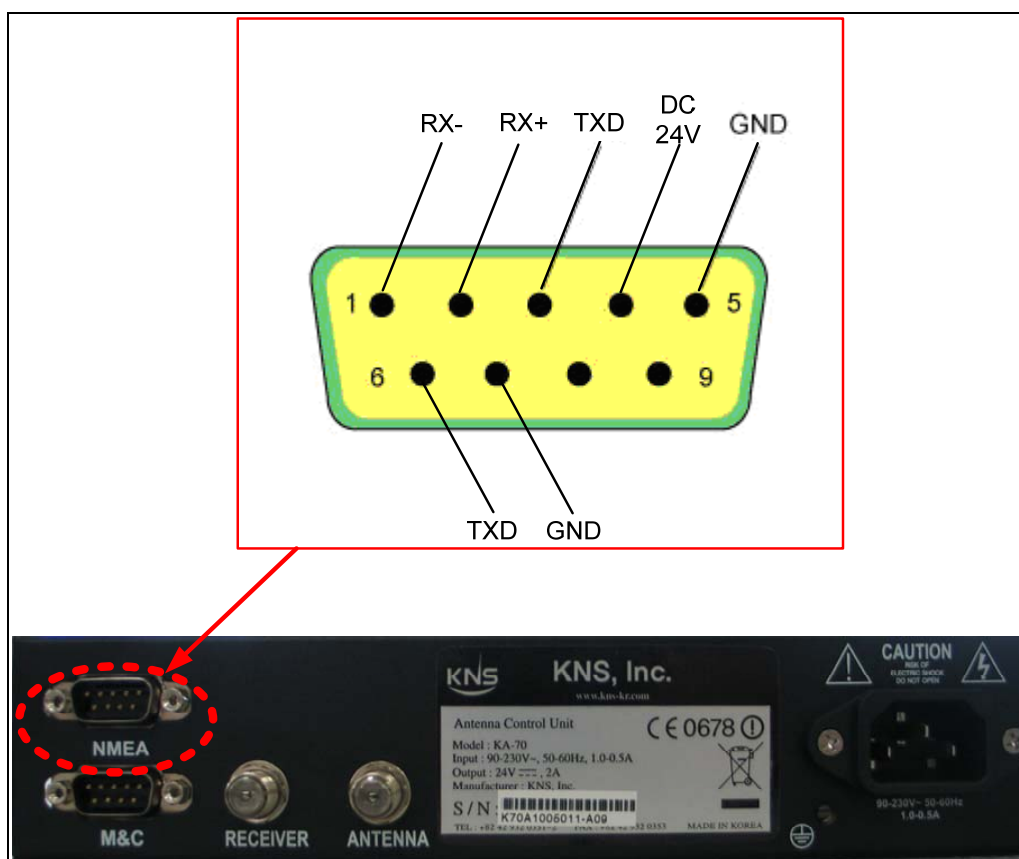

Figure 2-11 NMEA connector



Figure 2-12 Female-type 9-pin connector

### Gyro Cable Connection

The cable connection differs according to the type of NMEA. Connect the NMEA port with the ship's gyro, as indicated in Figures 2-13 and 2-14 below.

Pin No.	Pin Name
1	RX-
2	RX+
3	TXD
4	DC 24V
5	GND
6	TXD
7	GND
8	Dummy
9	Dummy

**Table 2-1 Using the pin number of the ACU Connector for the NMEA type**

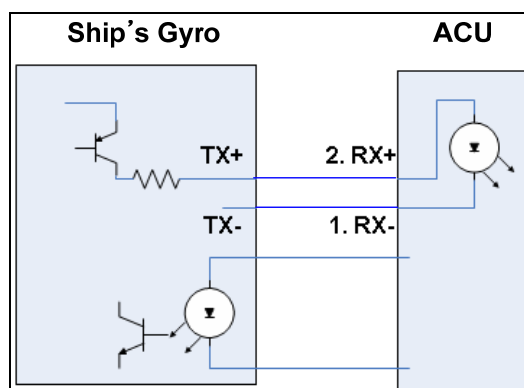

**Figure 2-13 Cable Connection NMEA 422/485**

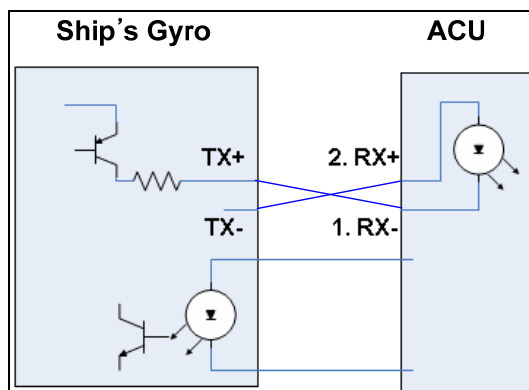

**Figure 2-14 Cable Connection NMEA 232**

**NOTE:** KA-70 ACU can receive the various format of NMEA, as follow: HDT; HDG; HDM. But NMEA signal must be matched the regular NMEA format as below.

\$HEHDT, x. x, T\*hh<CR><LF>

\$HEHDG, x. x, x. x, a, x. x, a\*hh<CR><LF>

\*hh means checksum of format. If there is no this checksum, KA-70 ACU can't receive the gyro signal.



## 2.7. Cable Connection

For the SuperTrack S8 to work, you must connect the RF cables to your satellite TV receiver(s). Each RF cable must be an RF (75 ohms) cable fitted with F-type connectors. The RF cables should already be connected to the antenna base plate. There should be two ~ five coax cables routed from the ACU to the Antenna unit according to your configurations. Note that Data and Power are transmitted through a single coax cable. **This cable should be connected to the ACU labeled “RF connector of the antenna base plate” and the connector of the ACU labeled “ANTENNA.”** The remaining coax cable routing depends on your configuration. Due to the signal polarization of the satellites, it is possible for the SuperTrack S8 to support more than two satellite TV receivers aboard a boat. To install more than two satellite TV receivers/TV pairs, an active multi-switch is placed between the Antenna Unit and the Satellite TV receivers. The following sections provide details for the installation of both a single satellite TV receiver and multiple satellite TV receivers.

To connect the SuperTrack S8 to your satellite TV receiver(s), choose one of the following configurations (based on the number of satellite TV receivers you will connect to the antenna):

- Option 1 - Connecting one satellite TV receiver for one satellite
- Option 2 - Connecting one satellite TV receiver for satellite pairs with auto switching
- Option 3 - Connecting satellite TV receivers with European LNB
- Option 4 - Connecting multi satellite TV receivers with auto switching

### ***Connecting one satellite TV receiver for one satellite (Only use the ‘HH’ polarity of the satellite)***

One satellite TV receiver for one satellite is the simplest type of cable installation. Only two coaxial cables should be connected between the antenna unit and the satellite TV receiver, as shown in Figure 2-15. One end of the RF cable should already be connected to the connector labeled “RF4” on the base of the SuperTrack S8 antenna. Connect the other end of the RF4 cable to the satellite TV receiver connector labeled “LNB,” “ANT/SAT,” or “satellite IN.” And, the “ACU” connector of the antenna base plate must also be connected to the “ANTENNA” connector of the ACU. In this configuration, every satellite should be selected manually using the ACU.

**NOTE:** Before you connect an RF cable to a satellite TV receiver, turn on the satellite TV receiver and TV and verify that there is no AC voltage on the satellite TV receiver's input connector, as measured between the center conductor and the shield. If AC voltage is present on the connector, DO NOT connect the RF cable until you have corrected the problem. This is a potentially dangerous condition that will damage the antenna's electronics.

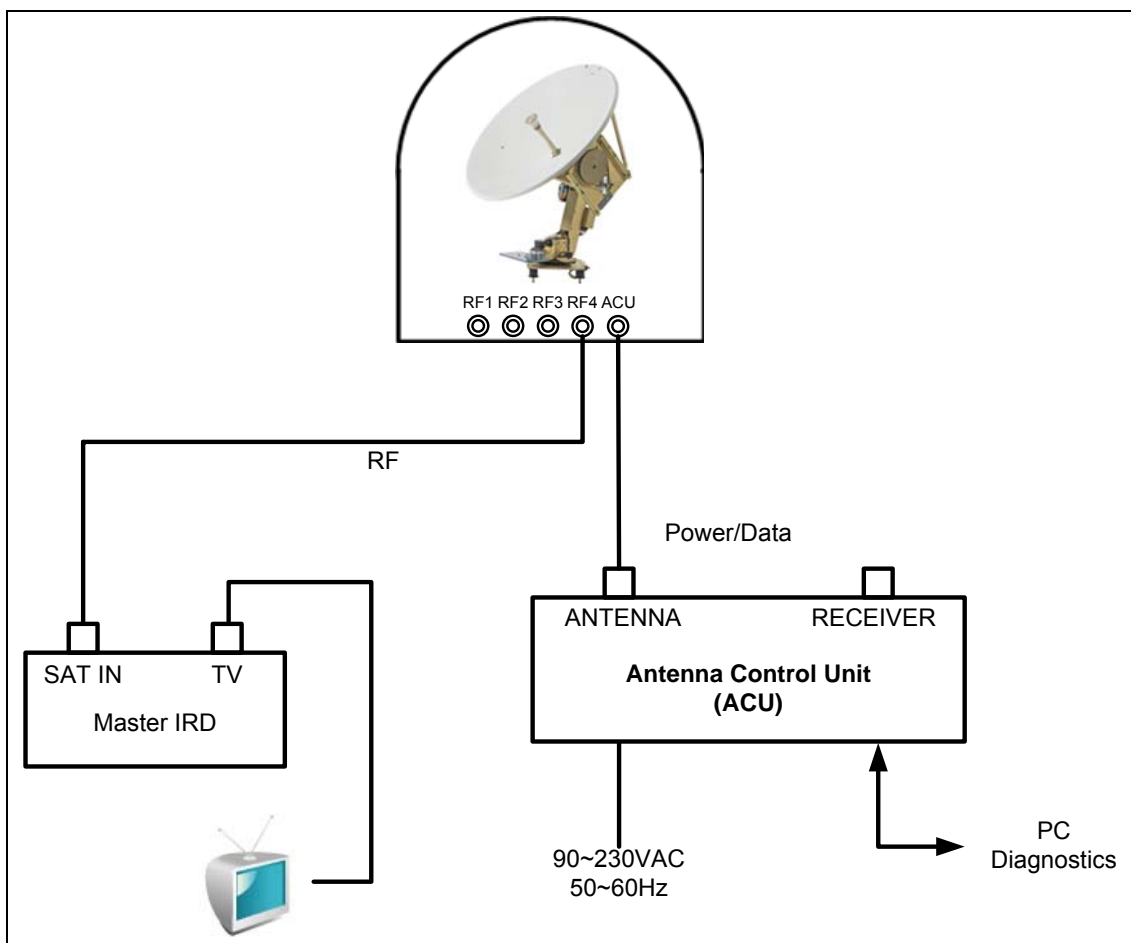
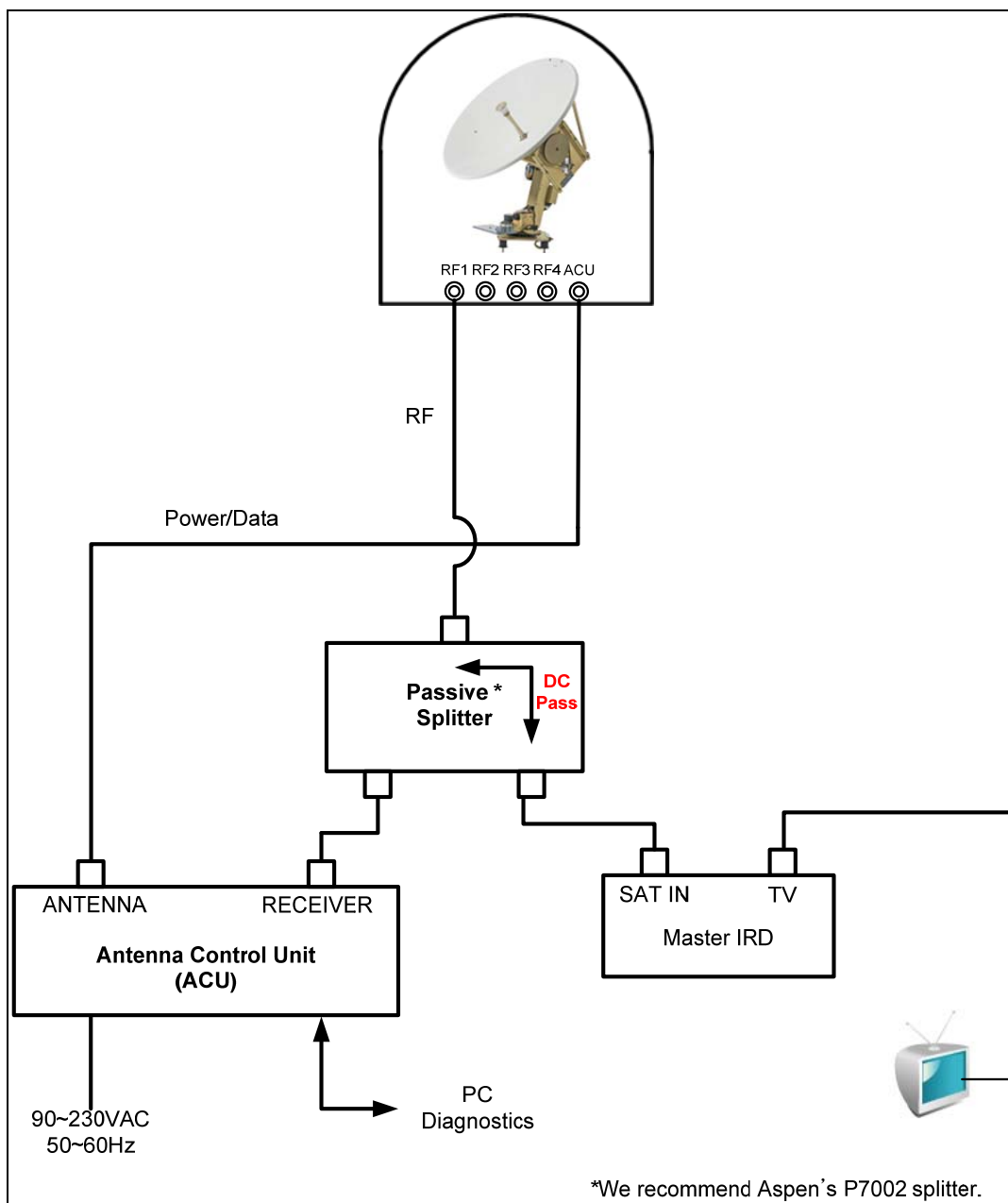

**Figure 2-15 One Satellite TV Receiver Installation**

**Connecting one satellite TV receiver for satellite pairs with auto switching (Only use the 'HH' polarity of the satellite)**

If you want to use two satellites with one satellite TV receiver, you can use automatic satellite switching using the DiSEqC. This versatility gives you the capability of receiving audio and video programming from two satellites. One satellite TV receiver for two satellites is also a simple mode of cable installation. Two coaxial cables should be connected between the antenna unit and the ACU, as shown in Figure 2-16. And,

one coaxial cable and a passive splitter should be connected between the ACU and the satellite TV receiver. The RF4 connector of the SuperTrack S8 must be connected to the “SAT IN” connector of the satellite receiver. And, the “ACU” connector of the Antenna unit must also be connected to the “ANTENNA” connector of the ACU. In this configuration two satellites can be selected automatically according to the satellite TV receiver signal. (Refer to the ‘PROGRAM SATELLITE’ section.)



**Figure 2-16 One Satellite TV Receiver with Auto Switching**

**Connecting satellite TV receivers with European LNB (Use of the all polarity of satellite)**

In European systems that come with a Quattro LNB (optional Quad LNB), all four RF outputs from the SuperTrack S8 antenna should be connected to the multi-switch. Connect each of the satellite TV receiver's inputs to the output connectors on the multi-switch. Connect the multi-switch unit in accordance with the manufacturer's instructions. Figure 2-17 shows an example of a European multi-switch (4 inputs and 4 outputs) configuration.

RF1: Low Band Vertical

RF2: Low Band Horizontal

RF3: High Band Vertical

RF4: High Band Horizontal

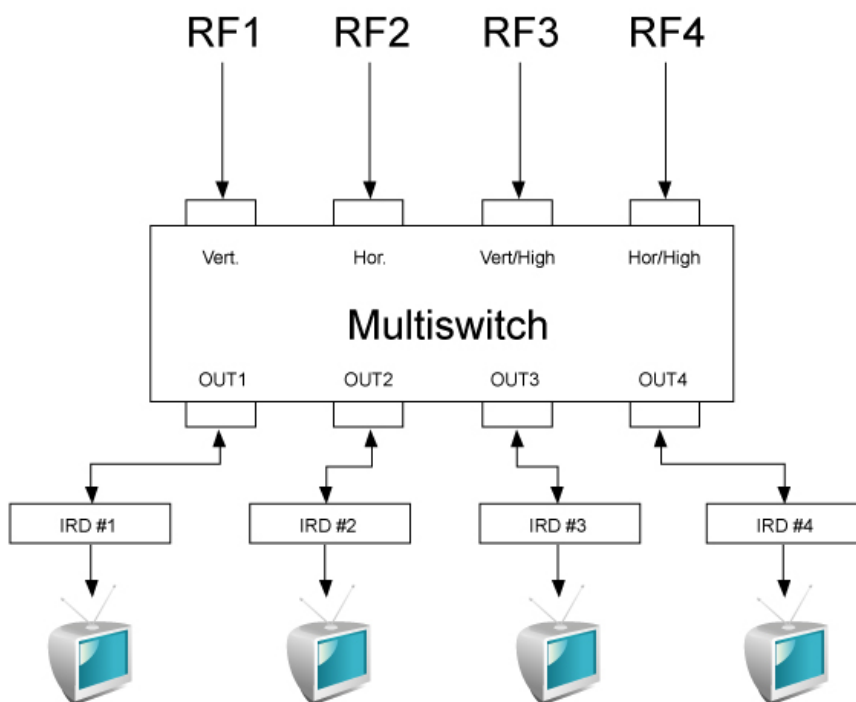
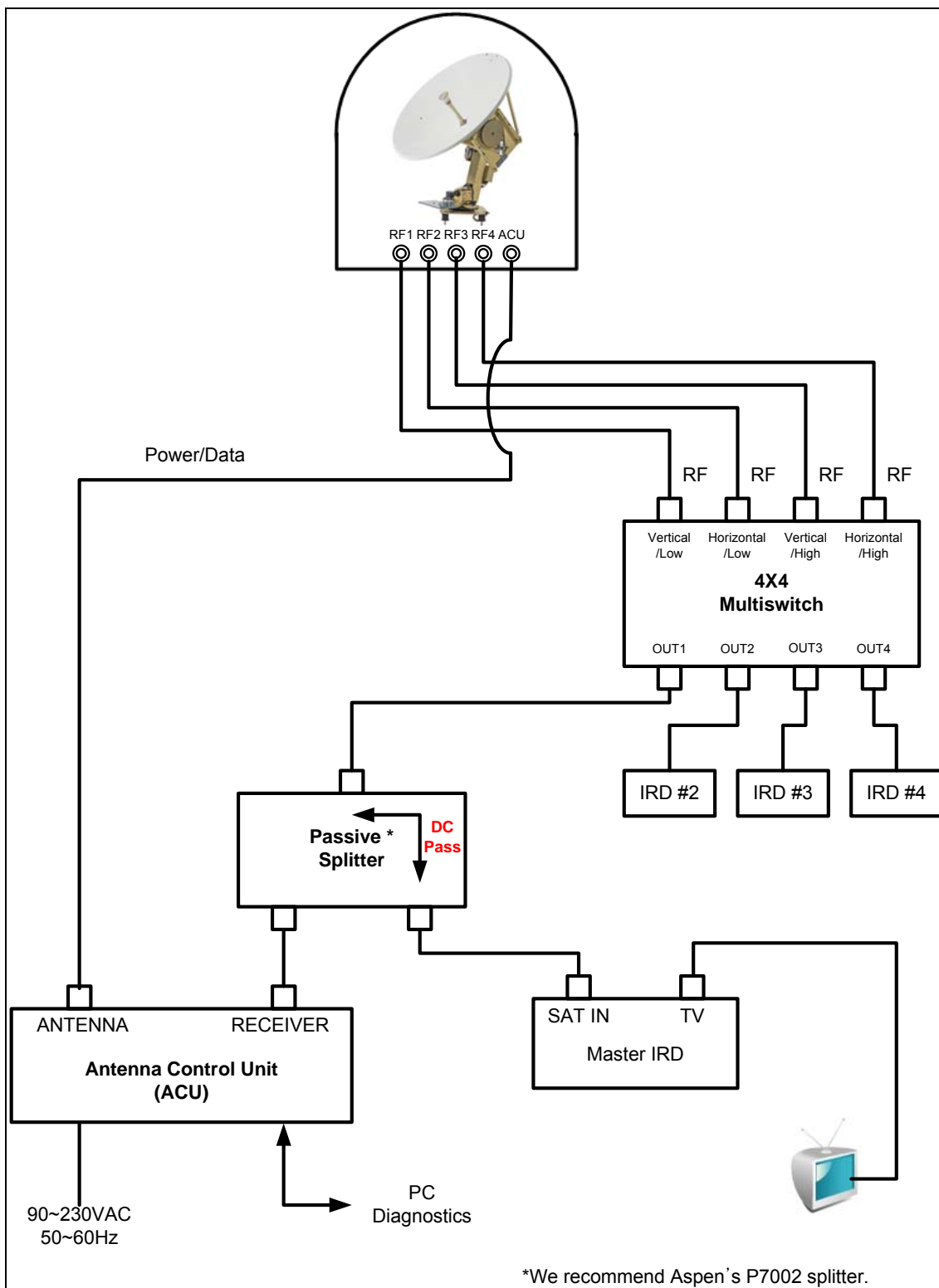

*Figure 2-17 Four Satellites TV Receivers Installation with European LNB*

If you want use more satellite TV receivers than four, you can choose 8 outputs or 16 outputs.

### ***Connecting satellite TV receivers signal with European LNB when auto switching using the DiSEqC signal (Use of the all polarity of satellite)***

If the satellite TV receiver supports the DiSEqC function, you can automatically change the satellite using DiSEqC. To send the DiSEqC signal to the ACU via the satellite TV receivers, one splitter should be installed between the Master satellite TV receiver and the ACU, as shown in Figure 2-18. As a result, the ACU will receive the signal to change satellites when you change channels using your satellite TV receiver.



**Figure 2-18 Installation of Four Satellites' TV Receivers with European LNB when auto-switching the satellite using DiSEqC**

***Connecting multi satellite TV receivers with auto switching (Use the circular polarity of satellite)-S8 can be mounted with optional circular LNB for option.***

To connect three or four satellite TV receivers to the SuperTrack S8 antenna, you will need to install an active multi-switch (Channel Master - model 141FD or equivalent) between the antenna and the satellite TV receivers. Two RF cables should already be connected to the connectors labeled “RF3” and “RF4” on the base plate of the SuperTrack S8 antenna. Figure 2-19 shows a typical wiring arrangement for four satellite TV receivers. Mount the multi-switch unit in accordance with the manufacturer’s instruction sheet.

One satellite TV receiver will be connected to the ACU via a passive splitter. This satellite TV receiver serves as the master satellite TV receiver and will control automatic satellite switching via DiSEqC signals. But the splitter and multi-switch should be purchased separately. The “ACU” coaxial cable should be connected between the antenna unit and the ACU. Then, connect the RF cable labeled “RF4” to the multi-switch input labeled “LNB LHCP +18V.” And, connect the RF cable labeled “RF3” to the multi-switch input labeled “LNB RHCP +13V.” The outputs of the multiswitch will then be routed to the individual satellite TV receiver input. Use an RF cable with F-type connectors for all RF connections. Terminate all unused output connectors with 75 ohm DC blocks. Depending on the length of the cable, you may need to use cable clamps or wire ties (not provided) between the ACU and the Antenna Unit.

To send the 22 KHz tone to the ACU via DIRECTV DSS Plus satellite TV receivers, one splitter should be installed between the Master satellite TV receiver and the ACU. As a result, the ACU will receive the signal to change satellites when you change channels using your DIRECTV DSS Plus remote. It is also compatible with the DISH NETWORK DISH500 service. If the DISH NETWORK satellite TV receiver sends a command to the ACU, the ACU will decode the command for SW21 to change satellites, emulating a simple SW21 device. As a result, DISH NETWORK subscribers can change satellites using their remote.

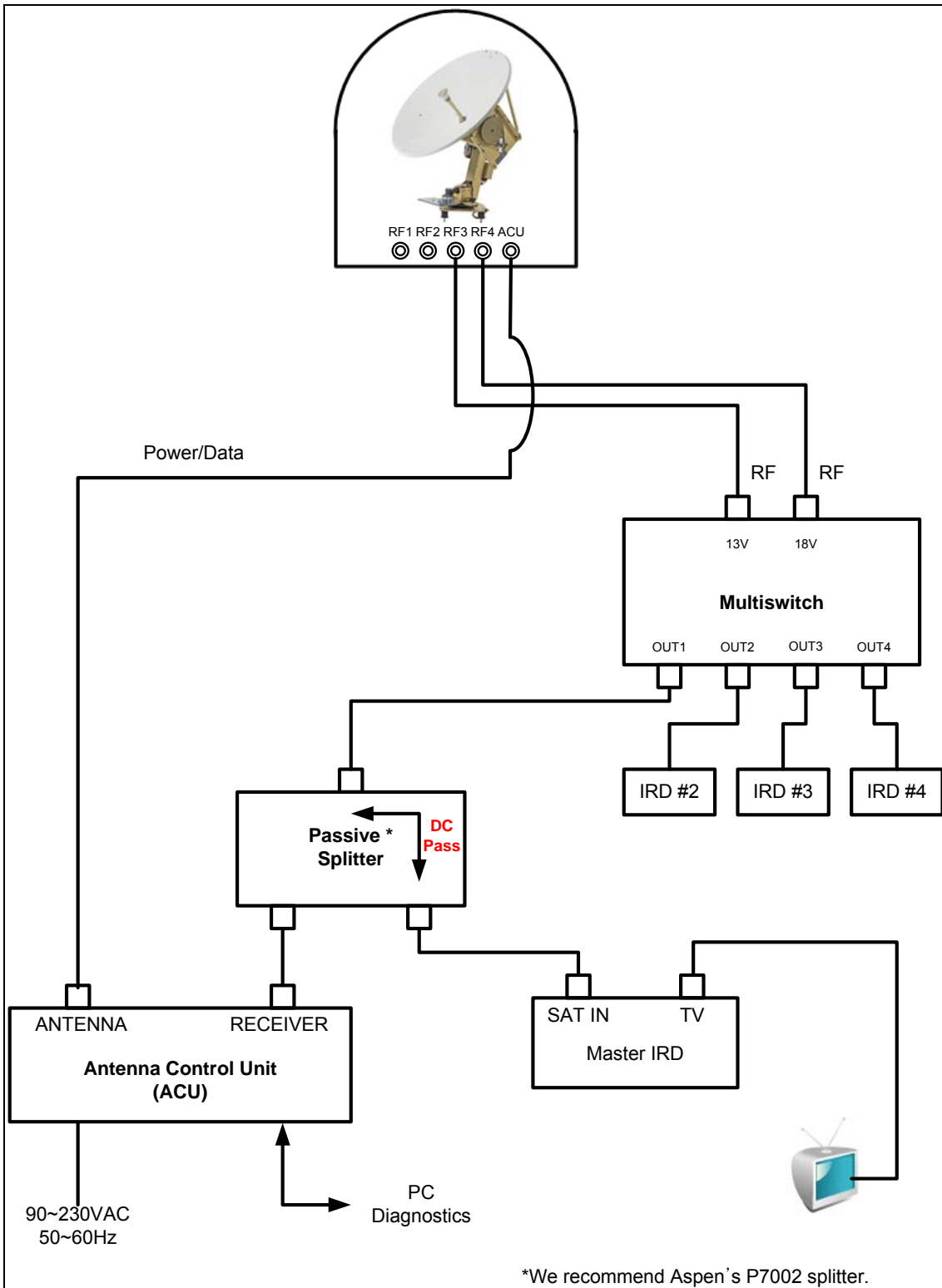

**Figure 2-19 Multi-satellite TV receiver Installation with Auto-Switching**



## 3. Operation

### 3.1. Front Panel Functions

1. **MENU** button – Press the MENU button for more than 3 seconds to enter the set-up mode. When you want to escape from the set-up mode, press MENU again for more than 3 seconds. Another function of the MENU button is that of checking the error message when the S8 makes an error. When the error LED is on, press the MENU button briefly. Then, you will be able to see the hexadecimal error message. Please press the NEXT button for about 2 seconds to clear the error. If you press MENU briefly again, you can go back to normal operation.

**NOTE:** Operator can make sure the communication status of ACU and antenna as below when press MENU and press SEARCH shortly again. Packet means the number of command from ACU, loss means the number of loss on the PCU. The more loss this display, communication status is not good.

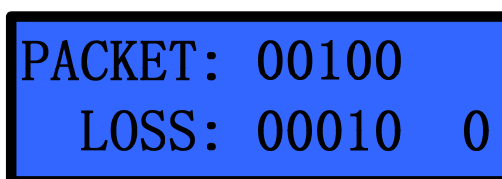

```
PACKET: 00100
LOSS: 00010 0
```

Figure 4- 1 *Packet Loss*

2. **TRACK** button – Press the TRACK button to enter the stall mode. The antenna does not move from the position when the TRACK button is pressed. This button is also used to scroll left (◀) in the menu.

3. **NEXT** button – Press the NEXT button to select your preprogrammed next satellite. When your desired satellite is displayed, stop pressing NEXT, and then, after 3 seconds, the antenna automatically searches for your desired satellite. Use this button when you want to scroll right (▶) in the menu.

4. **M/C** button – Press M/C for more than 3 seconds to enter computer link via RS 232. When you want to escape from computer link, press M/C for more than 3 seconds. This button is also used to scroll up (▲) in the menu.

5. **SEARCH button** – Press SEARCH for more than 3 seconds to re-search for the current satellite. This button is also used to scroll down (▼) in the menu.
  
6. **PWR button** (Power button) – Use this button when you want to turn on/off the antenna unit power.
  
7. **TRACK LED** – **Blinking** indicates that the antenna is searching for the satellite.  
**ON** indicates that the antenna is tracking the satellite.  
**OFF** indicates that the antenna is in the stall mode or initializing.
  
8. **GPS LED** – **Blinking** indicates that the antenna has distinguished the GSP but that the GPS data is invalid.  
**ON** indicates that the antenna is receiving valid GPS data.  
**OFF** indicates that the GPS antenna is not installed or is malfunctioning.
  
9. **DiSEqC LED** – **Blinking** indicates that DiSEqC option is selected as 22KHz tone.  
**ON** indicates that the DiSEqC option is selected as DiSEqC 1.2 to switch satellites automatically.  
**OFF** indicates that the DiSEqC option is disabled. Press the NEXT button to select the next satellite manually.
  
10. **ERROR LED** – **ON** indicates that one or more discrete system errors have occurred. (Refer to Error Code)  
**OFF** indicates that no errors have occurred.

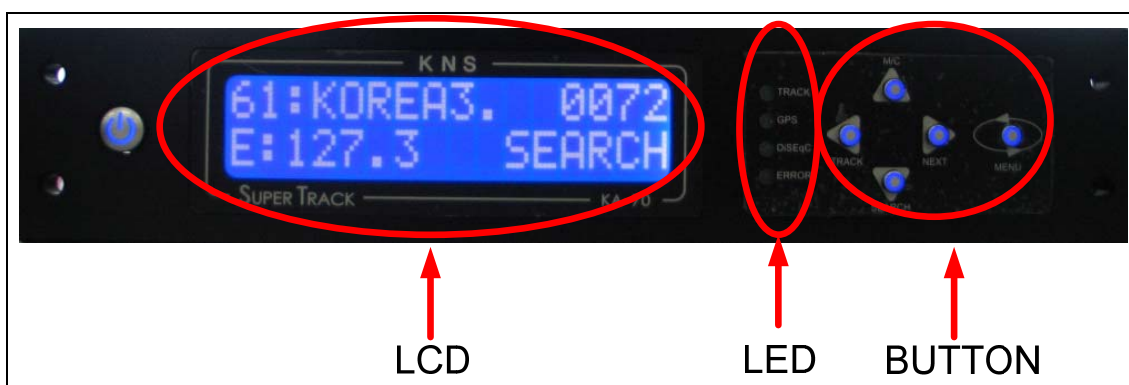

**Figure 3-2 Antenna Control Unit Front Panel**



Figure 3-3 Antenna Control Unit Back Panel

## 3.2. ACU Display Operation

If you turn on the power switch of the antenna control unit, you can view the steps shown in Figure 3-4 below.

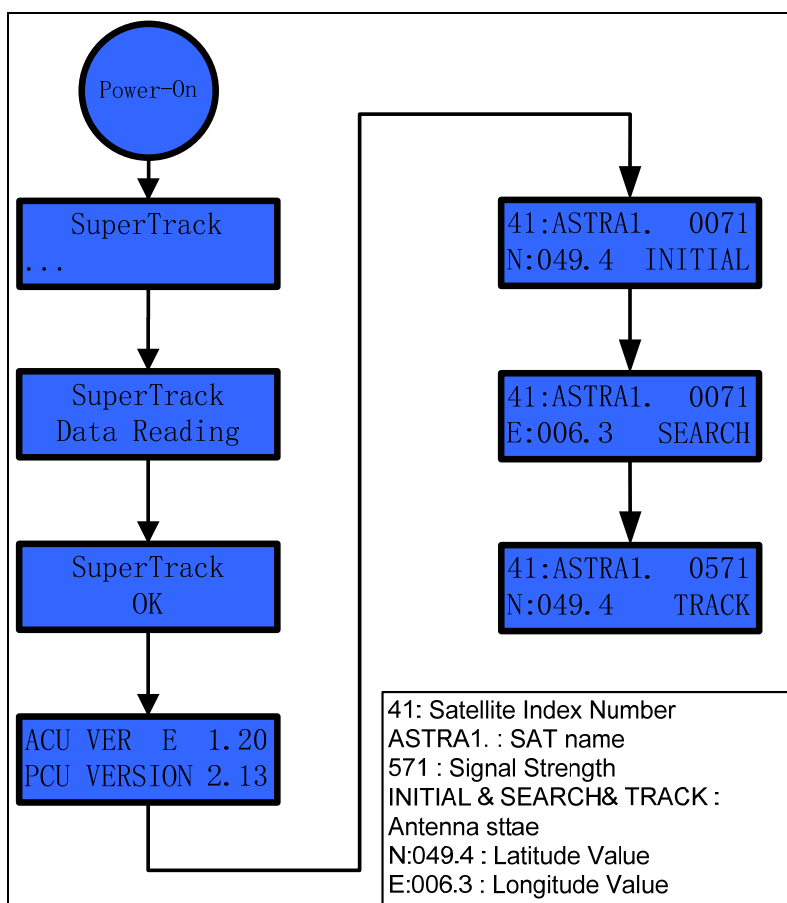

Figure 3-4 Display Flow on the ACU LCD

### Display of the Antenna State

**INITIAL (Initializing):** The ACU displays 'INITIAL' on the LCD when the antenna is initializing.

**SEARCH (Searching):** The ACU displays 'SEARCH' on the LCD when the antenna is searching for the satellite.

**LA:N 49 LO:E 6(GPS data: Tracking):** In the case of the internal magnetic mode, the ACU displays the GPS data on the LCD when the antenna is tracking the satellite. If the PCU compass mode is gyro, the ACU displays the ship's heading and GPS data on the LCD when the antenna is tracking the satellite. The display of the GPS data alternates, as shown in Fig 3-4 below.

**HALT:** If the antenna experiences the same control error twice within 3 minutes, the

PCU isn't supplying the torque to all motors to protect the antenna. In this case, the ACU will display 'HALT' on the LCD. The antenna continues in 'halt' mode until the ACU power has been reset.

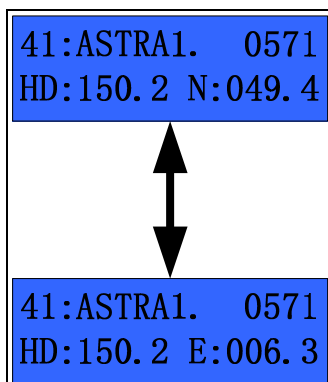

**Figure 3-5** *Display of tracking on gyro mode*

**NOTE:** For the first power-on of the GPS antenna, it will take about 5 minutes to calculate your location from the GPS satellites' signals and configure the database.

**NOTE:** Do not push any buttons during the self-diagnosis sequence.

### 3.3. Set-up Mode

Initial set-up is accomplished by the installer or operator using the SETUP Mode to configure the system parameters.

Press and hold the “MENU” button for more than 3 seconds to enter the SETUP mode. To navigate the menu, press the UP or DOWN button. The set-up mode has 10 sub-menus.

#### Upgrade

The installer or operator can change and configure the current parameters of the S8 by computer.

Connect the M&C port of the ACU to the serial port or the USB port of the computer with an RS-232 cable (Female to Female), as shown in Figure 3-6.



Figure 3-6 Connection ACU with Computer

If you want to connect to the PC, follow Figure 3-7 or Figure 3-8.

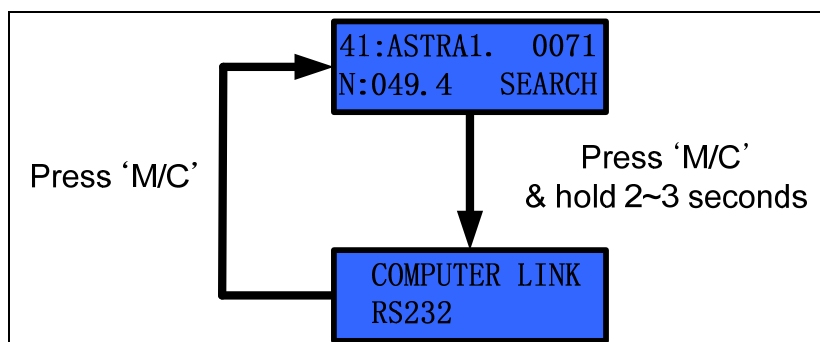

Figure 3-7 Computer Link step 1

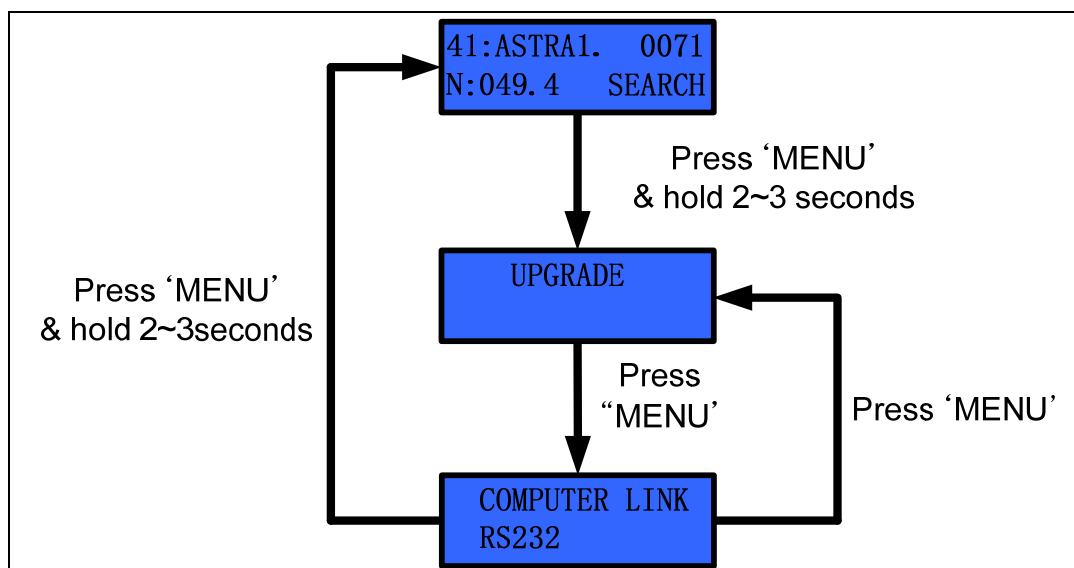

Figure 3-8 Computer Link step 2

### Set Latitude and Longitude

In the event of invalid GPS data or GPS breakdown, you can input the desired latitude and longitude. Refer to Figure 3-9. This data will be changed if the GPS data is valid or if the ACU power is reset.

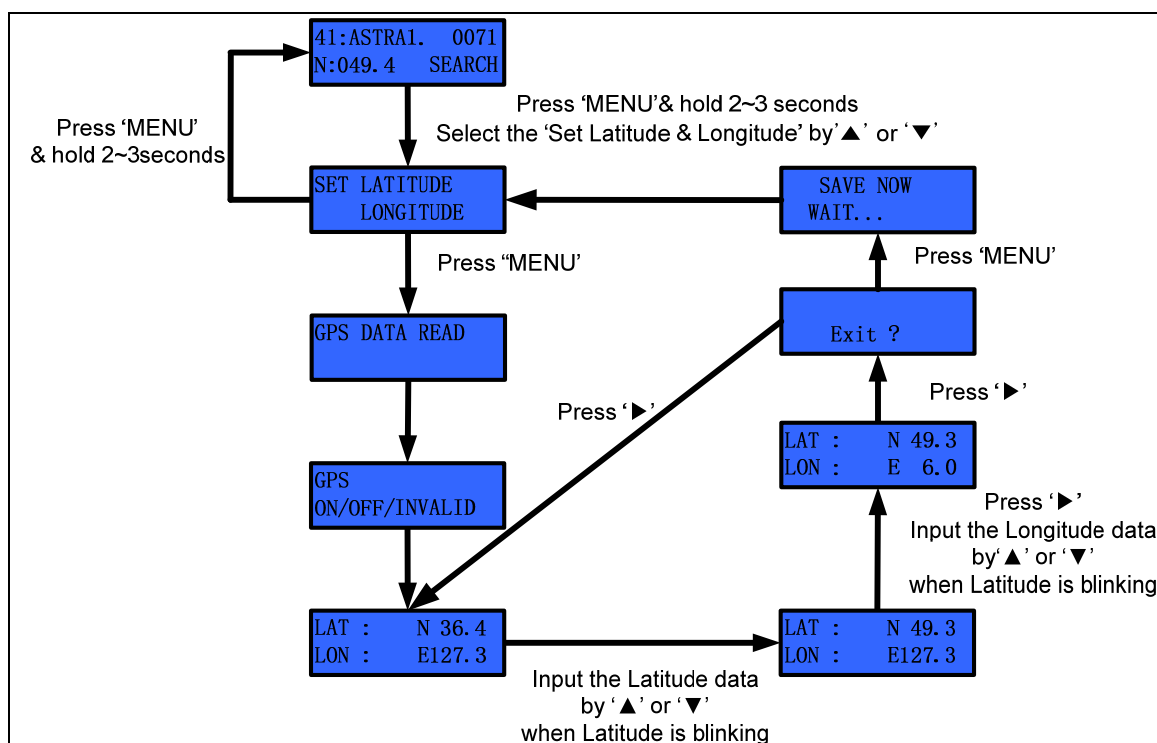

Figure 3-9 Set Latitude & Longitude step

## Program Area

Before you select your satellites, you have to select the service area from among Asia, Europe, Latin America, and North America.

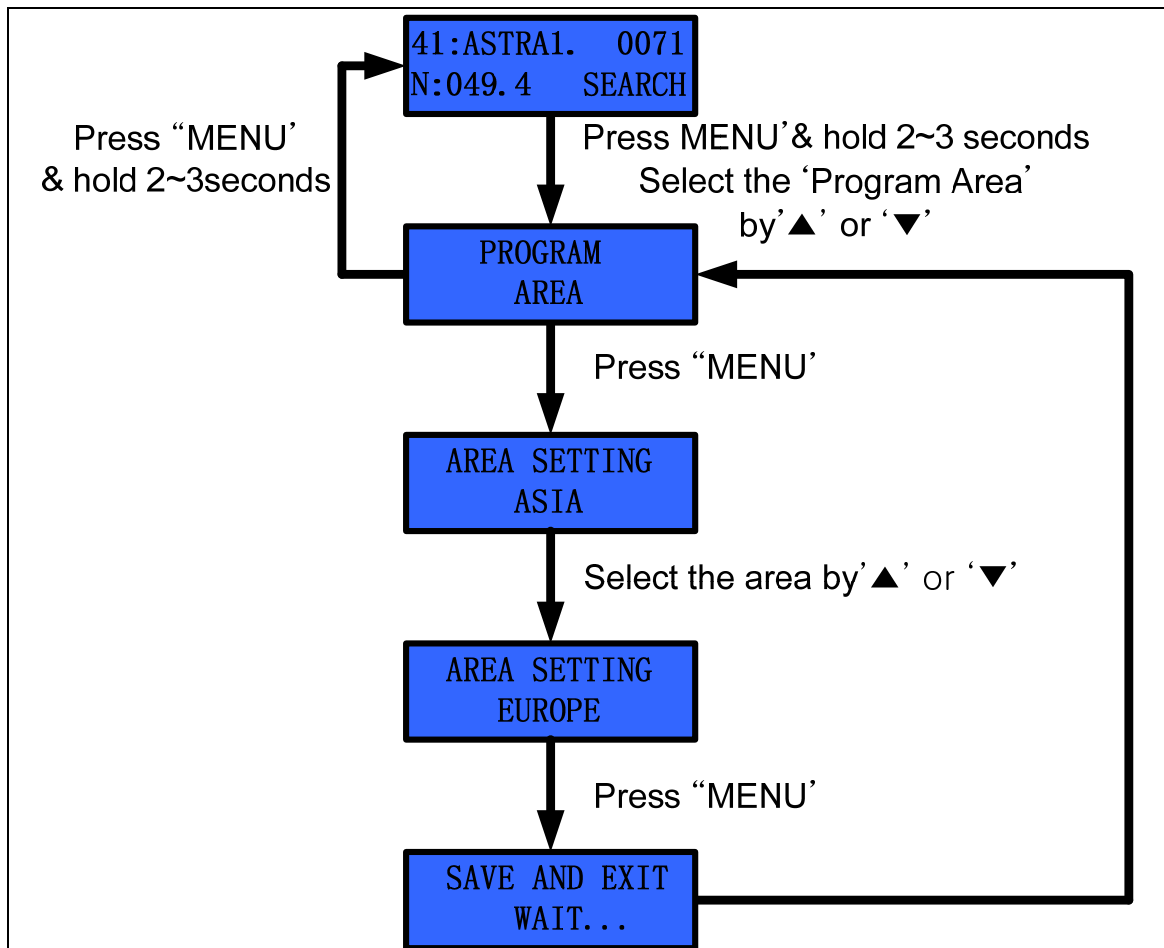

Figure 3-10 Program Area Setting Step

**NOTE:** The S8 has 80 satellite IDs, and each area has the parameters of 20 satellites, as shown below.

- North America: Sat ID 1~20
- South America: Sat ID 21~40
- Europe: Sat ID 41~60
- Asia: Sat ID 61~80

**NOTE:** If you select a different area from your area, the ACU will display SH FAIL (Searching Fail) on the LCD and the antenna will point toward the appointed position after initialization.

**NOTE:** All satellites on the same area share the LNB local frequency.



## Program Satellite

The user can select up to 5 desired satellites on KA-70 ACU. The user has to select the DiSEqC mode from among either DiSEqC off or the DiSEqC 1.2 or 22 KHz tones before selecting the satellites.

If DiSEqC off is selected, the user can change the desired satellite using the ► (Next) button. After selecting the satellites from A to E, the KA-70 ACU changes the satellite when the user presses the ► (Next) button.

In the case of 22 KHz, firstly, the ACU commands the antenna to search for the 'SAT\_A' and then, if the ACU receives the 22 KHz tone via the 'receiver' port of the AUC back panel, the ACU commands the antenna to search for 'SAT\_B'. But this function requires the 22 KHz tone from the satellite TV receiver.

**NOTE:** If DiSEqC 1.2 is selected, the DiSEqC LED will turn on. Also, the satellite cannot be changed using the ► (Next) button.

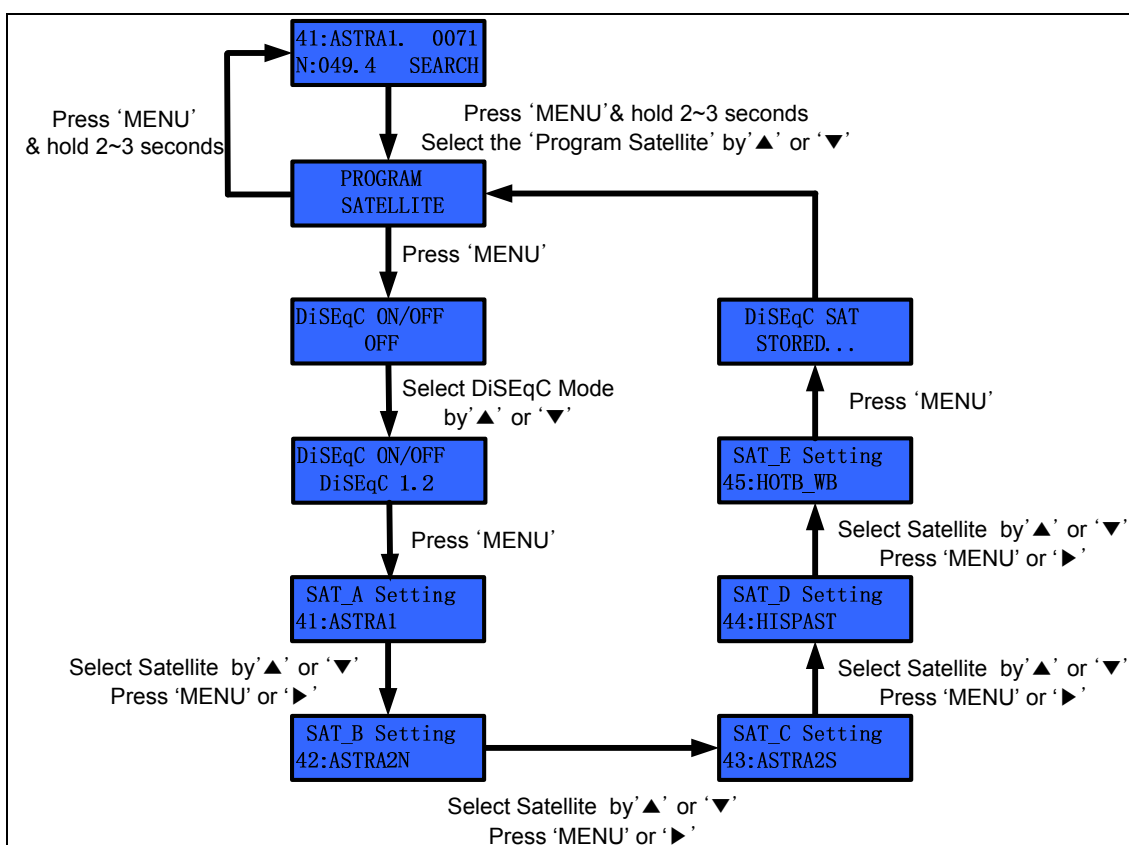

Figure 3-11 Program Satellite Setting Step

### Skew Angle Setting

The S8 calculates the skew angle automatically. However, if the user wants to change the skew angle, he/she can change the skew angle using the 'Manual Mode'. The user can also readjust the skew zero position when replacing the PCU, skew assembly or potentiometer.

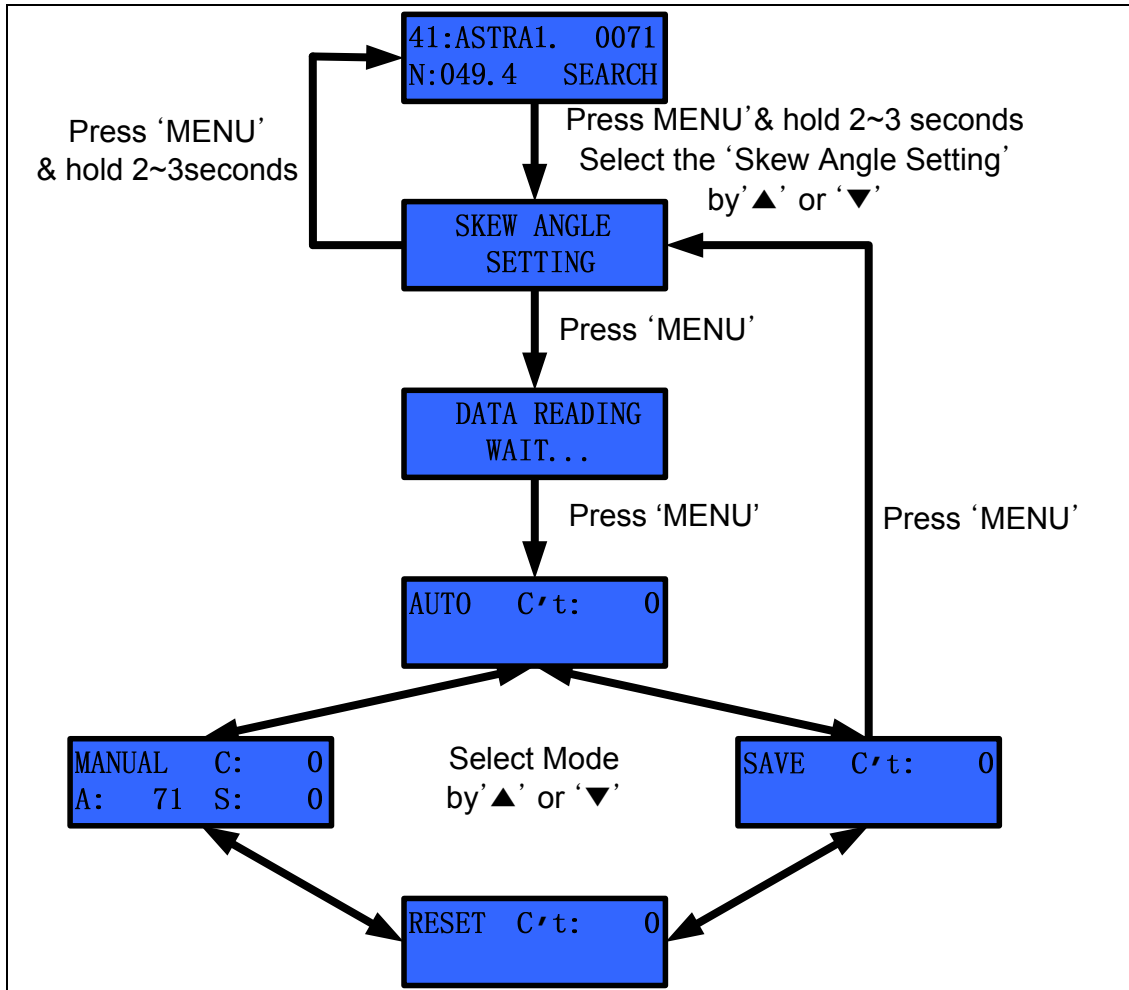

Figure 3-12 Setting the Skew Mode

**a. Auto Mode**

In the Auto mode, the ACU displays the skew angle calculated by the PCU. The S8's default skew mode is auto. The S8 automatically changes the skew angle when the satellite is changed.

**b. Manual Mode**

The Installer or Operator can change the skew angle to the desired skew angle, as shown below.

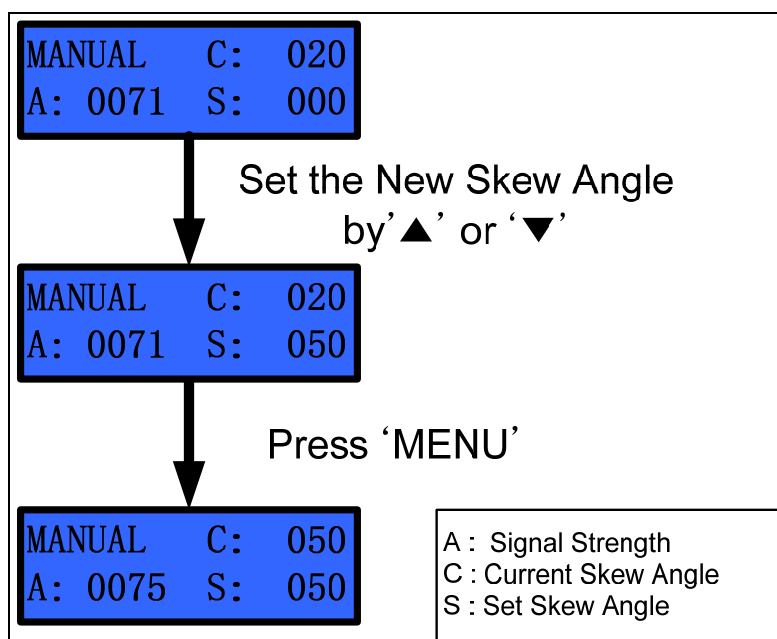

**Figure 3-13 Setting the Skew Angle in Manual Mode**

**NOTE:** 'C:' refers to the current skew angle. 'A:' refers to signal strength. 'S:' refers to the user setting the skew angle.

### c. Reset

After replacing the PCU board or the skew assembly, you have to re-adjust the skew zero position. Otherwise, the SuperTrack S8 cannot search for the desired satellite. Also, correction of the skew angle is important because the signal level is influenced by the skew angle.

If 'RESET' is selected and 'MENU' is pressed at the desired skew angle, the skew angle will be set to '0' degrees. The skew angle affects signal strength, so we recommend that the user should correct the skew '0' degrees position, as shown in Figure 3-14 below.

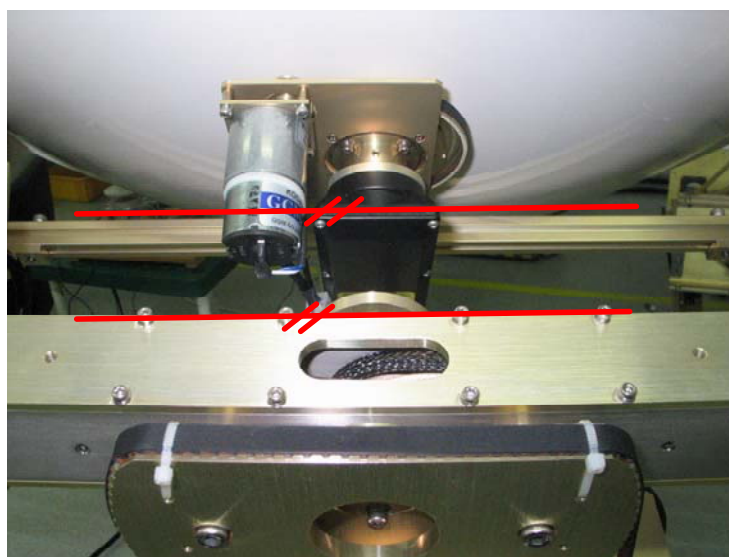

**Figure 3-14 Skew '0' degrees**

### d. Save

If you want to save the changed '0' degrees position, press 'MENU' after selecting the 'SAVE' mode.

### e. Exit

If you want to escape, press 'MENU' after selecting the 'EXIT' mode.

### Demo Mode

The S8 points toward the desired position when using the 'Demo Mode'. It is very useful when the dealer requires a demonstration inside a building. Elevation is changed every 5° by one click of '▲' or '▼'. Azimuth is changed every 10° by one click of '▶' or '◀'.

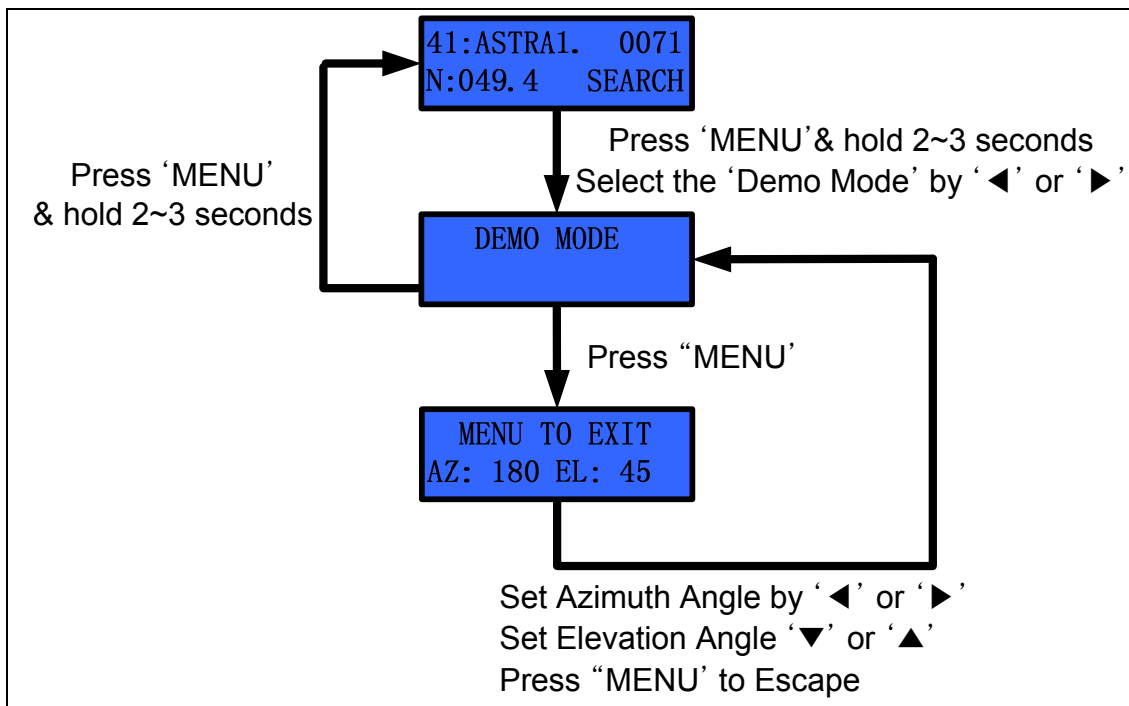

**Figure 3-14 Setting the Skew Angle in Manual Mode**

## Selecting the Compass Mode

You can select the compass mode according to the condition of your ship's gyro. The S8 has 4 compass modes.

### a. Gyro Mode

Select the Gyro Mode when using the ship's gyro (only the NMEA type). For the gyro cable connection, refer to '2.6 Gyro Connection'.

### b. Internal Magnetic Mode

If your ship is not made of magnetic metal (ex: aluminum, FRP), you can use the internal magnetic mode. However, the internal magnetic compass value will be incorrect if ship is made of metal, because the internal magnetic compass will be affected by the magnetic field of a metal-based ship.

**NOTE:** We do not recommend use of the 'Internal Magnetic Mode' on metal ships.

### c. Gyro Fail Mode

Use this mode when a gyro compass is not available. The S8 receives the ship's heading as a reference angle when satellite selection or searching or re-searching after searching fail. And, the S8 uses the gyro rate sensor value during searching and tracking.

### d. Magnetic Fail Mode

Use this mode when an internal magnetic compass is not available. The S8 receives the internal magnetic compass value as a reference angle when satellite selection or searching or researching after searching fail. And, the S8 uses the gyro rate sensor value during searching and tracking.

**NOTE:** We recommend 'Gyro Mode' to ensure a reliable heading angle. If your ship does not have an NMEA signal, please contact us. We supply external NMEA converters (for converting 'synchro' or 'step by step' signals to NMEA signals). This is optional.

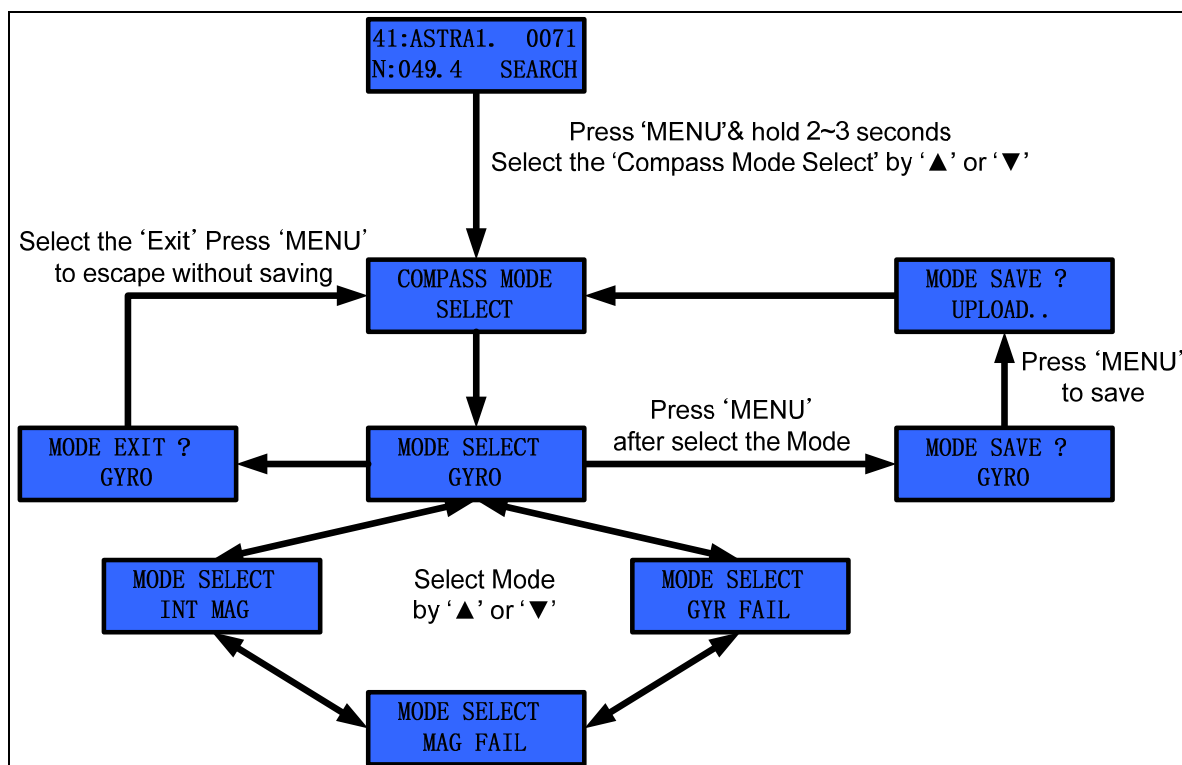

**Figure 3-16 Selecting the Compass Mode**

**NOTE:** When using the gyro fail and magnetic fail modes, the ship's gyro must not rotate during initializing. If the ship's gyro rotates, the S8 will not be able to track the satellite due to the incorrect heading angle.

### Satellite Edit

Operator can edit the 5 satellites that be selected satellite on the 'SAT\_A' to 'SAT\_E'. If you select 'Satellite Edit', you can change the 5 satellite's name.

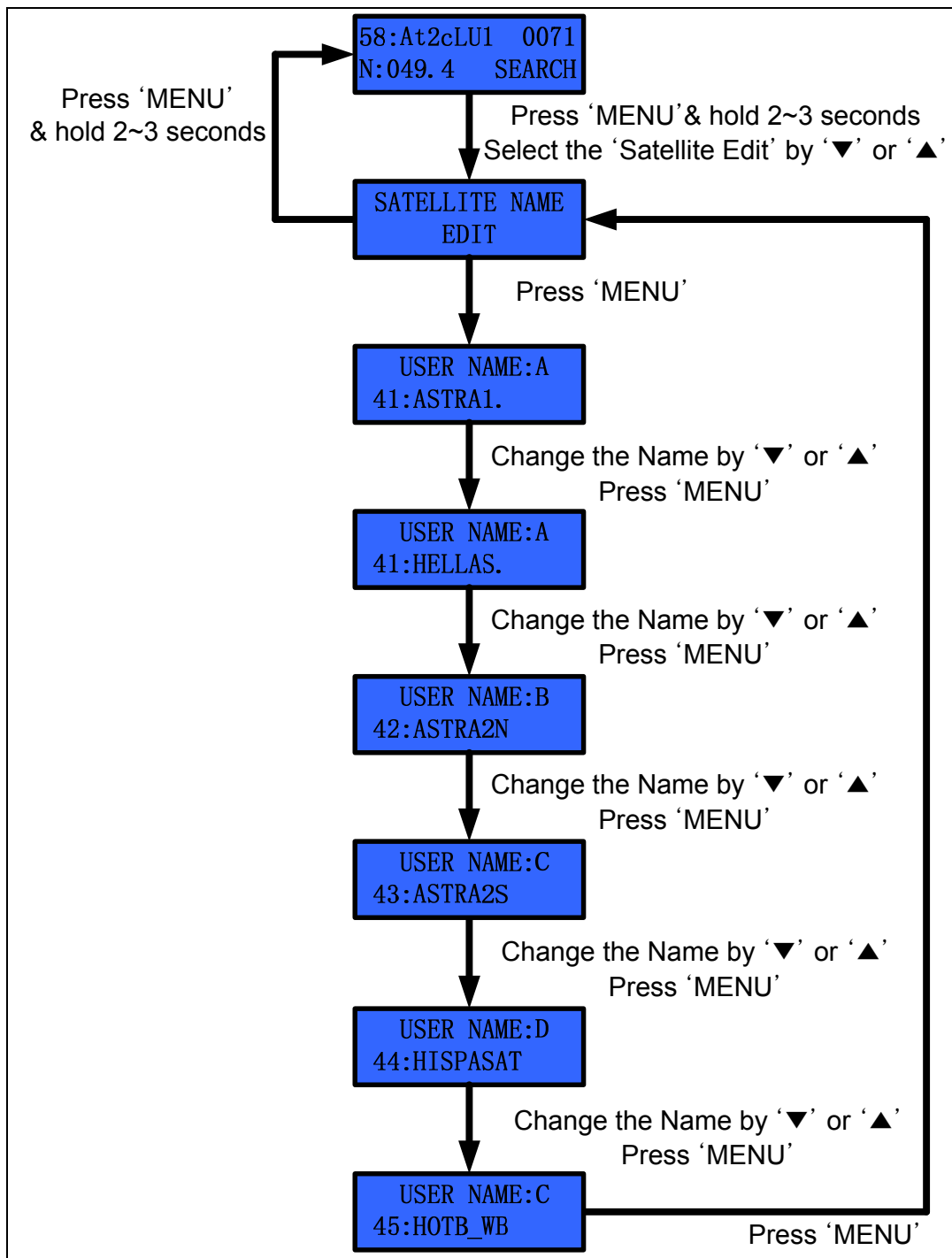

Figure 3-17 Edit User-Settable Satellite Name



## 4. How to Operate the SCS

The installer or operator can change the parameters using SCS (SuperTrack Control Software) Version 1.6.1. Also, SCS can show the current status of the S8.

### 4.1. Connect to PC

After connecting to a PC, as shown in Figure 3-5, run the SCS. Press M/C and hold for 3 seconds or select 'Upgrade' in the set-up mode.

Then, select the COM port of your computer, and select the baud rate of 19200. Lastly, click 'DISCONNECT', whereupon the S8 will be connected with the computer.

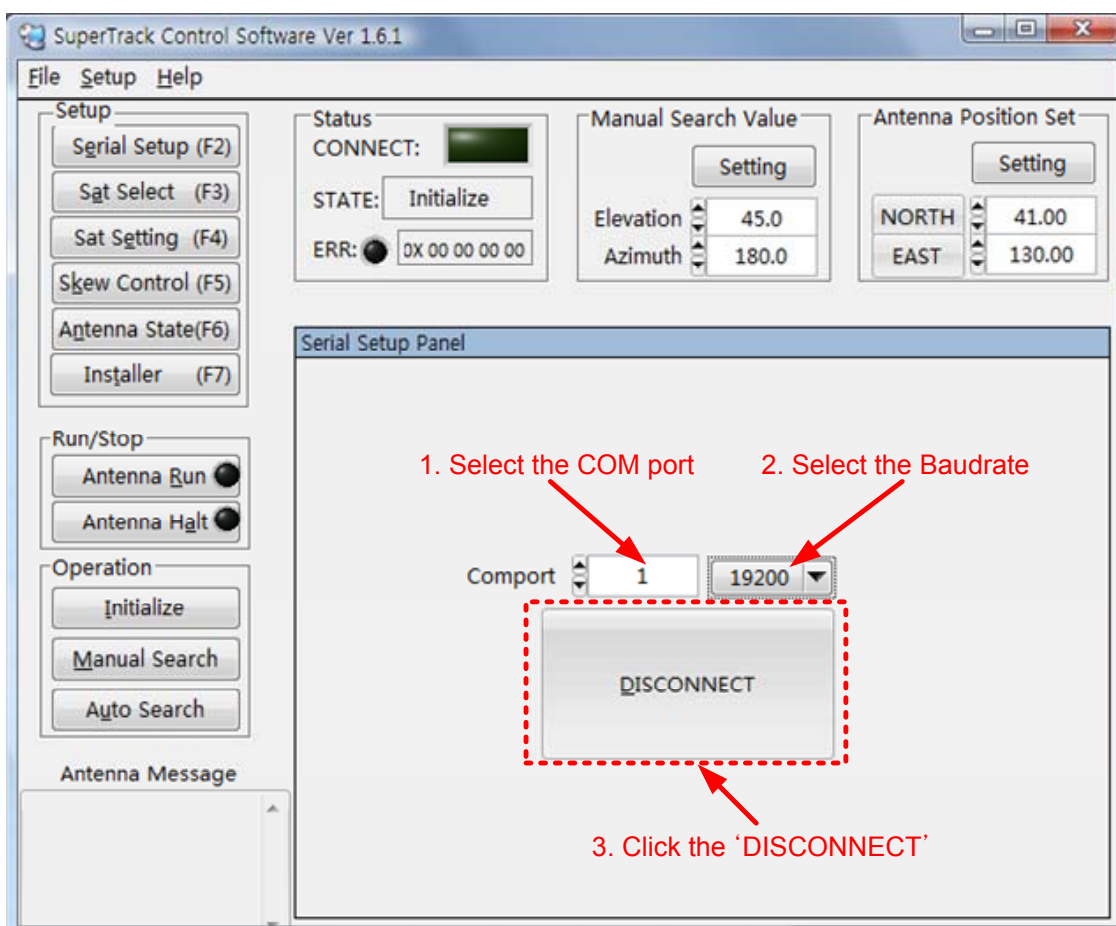

Figure 4-1 Connecting the S8 with a PC

You will be able to see that the 'CONNECT' LED of the status panel is on, as shown in Figure 4-2. Also, you can see the current state of the antenna, which is one of 'Initialize', 'Searching' 'Searching Fail', 'Tracking', and 'HALT'.

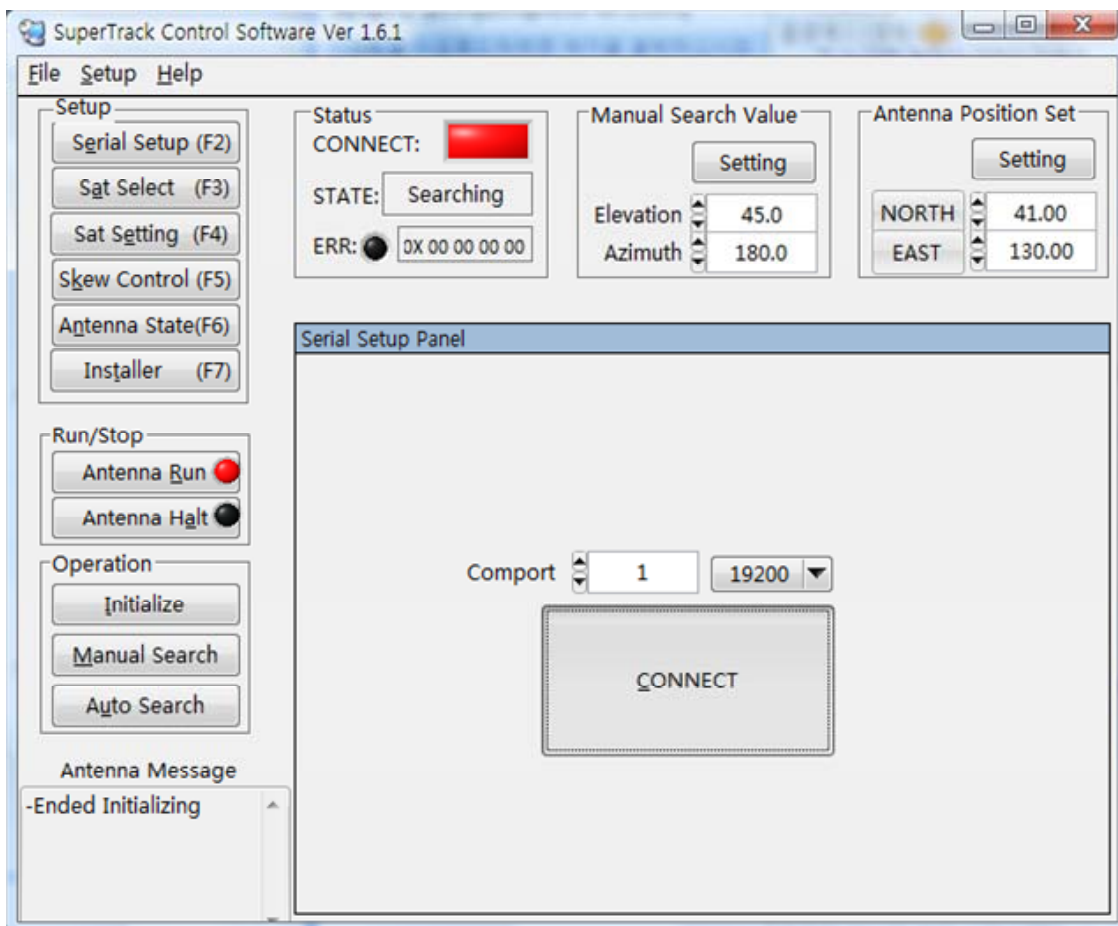

Figure 4-2 Connection Status of S8 with PC

## 4.2. Selection Area and Satellite

You can select the area and satellite using SCS. Refer to the steps outlined below and to Figure 4-3.

- a. Click 'Sat Select' (F3) or press F3.
- b. Select the area in 'Zone Select'.
- c. Select the satellite in 'Satellite Select'.
- d. Press 'Send' to upload to the PCU.

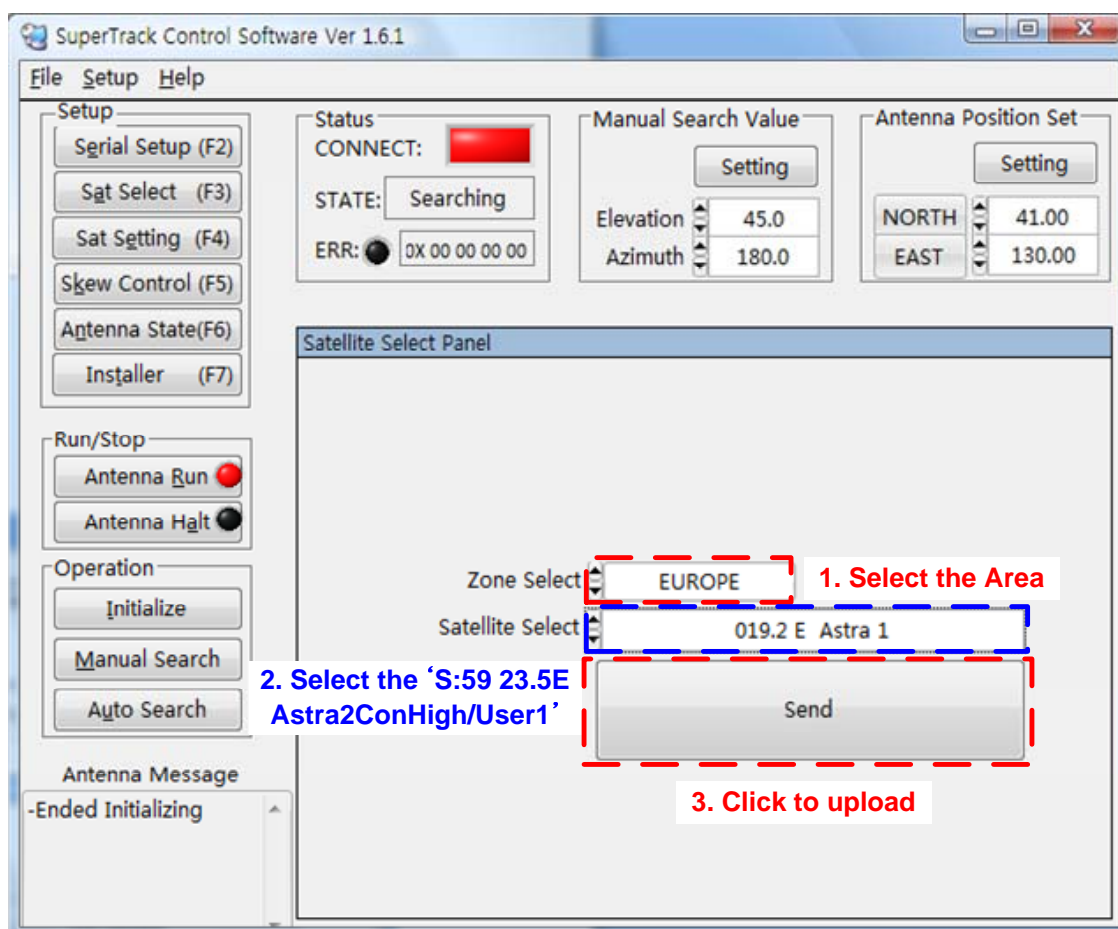

Figure 4-3 Select Area and Satellite Step

**NOTE:** The S8 has 4 areas (Europe, Asia, North America, and South America).

**NOTE:** The S8 has 80 satellites.

Sat ID 1~20: North America

Sat ID 21~40: South America

Sat ID 41~60: Europe

Sat ID 61~80: Asia

## Edit the Satellite Parameters

If you select the user-settable satellite or if the desired satellite's parameters are incorrect, you can change the selected satellite's parameters. Refer to the steps outlined below and to Figure 4-4.

- Click 'Sat Setting' (F4) or press F4 after selecting the desired satellite.
- Click 'Zone Info Request' and 'Sat Info Request' to update from the PCU. Then, the target satellite's parameters and the LNB local frequency will be uploaded to the satellite setting panel from the PCU.
- If you want to change the LNB local frequency, input the new local frequency and click the 'OK' button to upload to the PCU.
- Change the satellite's parameters and click each 'OK' button to upload to the PCU. (If you do not click after changing the parameters, the changed parameters will not be uploaded to the PCU.)
- Press 'Save' to save the changed parameters.

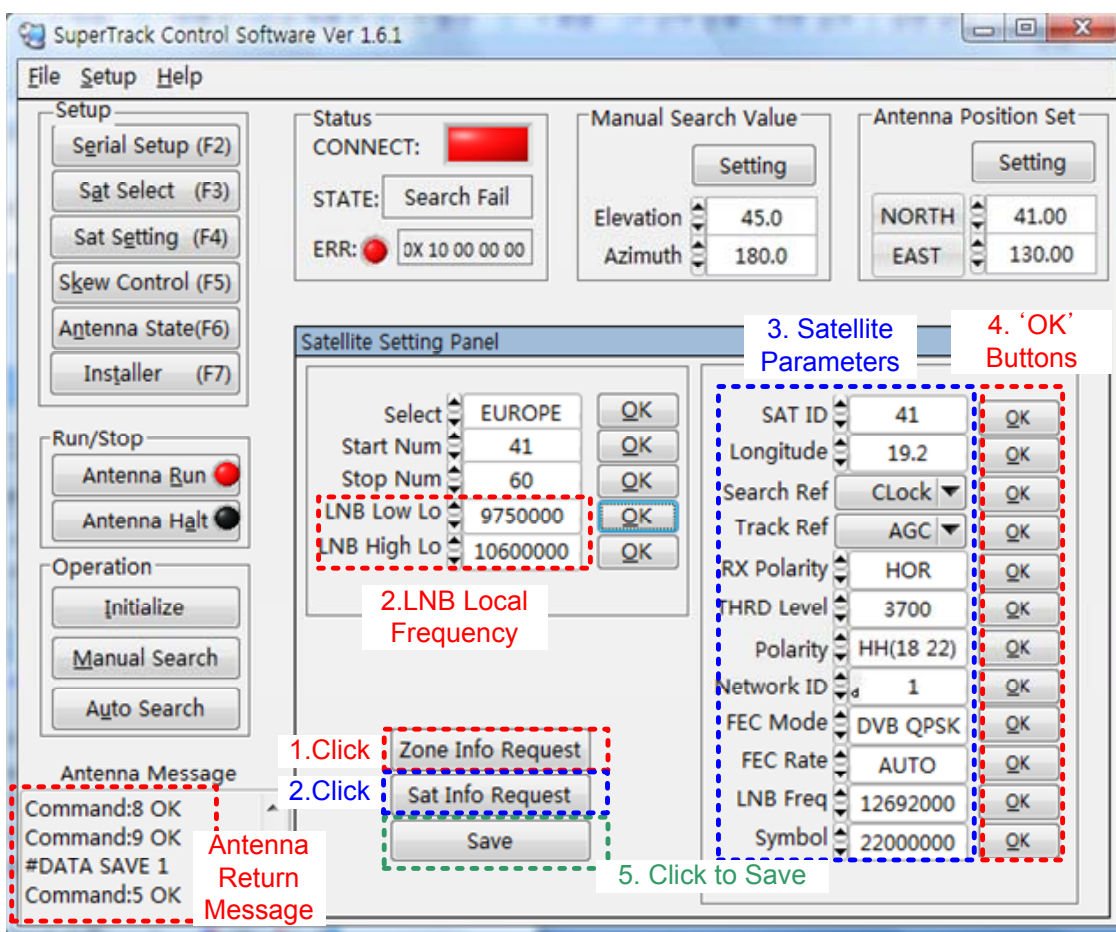

Figure 4-4 Edit the Satellite's Parameters

**NOTE:** The LNB local frequency is the same in the same area.

SAT ID refers to the satellite index, as shown below.

ID 1~13: North America

ID 21~26: South America

ID 41~60: Europe

ID 61~74: Asia

Search Ref refers to the S8 search reference that was used as a reference during the search for the satellite.

AGC THD: Search at a higher AGC level than the preset AGC level in the PCU.

C/N THD: Search at a higher C/N level than the preset C/N level in the PCU.

CLock: Search for the target DVB Carrier lock **(Default)**.

NLock: Search for the satellite until the NID is locked. **There is no function.**

Track Ref refers to the S8 tracking reference that was used as a reference during the tracking of the satellite.

AGC: Track the highest AGC level **(Default)**.

C/N: Track the highest C/N level.

RSSD (Receive Signal Detector): Track the highest RSSD value. **There is no function.**

RX Polarity refers to the RX polarity of the satellite.

Horizontal/Vertical

Network ID: If you know the correct network ID, input the correct value. Otherwise, input '0'.

FEC mode: Select the FEC mode (DVB QPSK, DVB BPSK, DSS QPSK) according to the target satellite's FEC mode.

THRD Level refers to the threshold level if the searching reference is AGC THD or C/N THD. The S8 searches for a higher signal than the threshold level.

Polarity refers to the voltage and tone of the LNB. The S8's is fixed to 'HH' because it uses Quattro LNB.

Linear LNB (Horizontal/Vertical, High/Low)

HH (18V, 22 KHz)

HL (18V, 0 KHz)

VH (13V, 22 KHz)

VL (13V, 0 KHz)

Circular LNB (Left Handed/Right Handed, High/Low)

LH (18V, 22 KHz)

LL (18V, 0 KHz)

RH (13V, 22 KHz)

RL (13V, 0 KHz)

LNB Freq refers to the RX frequency of the satellite.

Symbol refers to the symbol rate of the satellite.

### 4.3. Skew Setting

You can select the skew mode ('Auto' or 'Manual') by SCS. Also, you can change the skew angle to the desired skew angle.

#### Change the skew angle by manual mode

- Input the desired skew angle in 'Desired Manual Angle'.
- Click 'Skew Manual', then the skew will move to the desired angle.

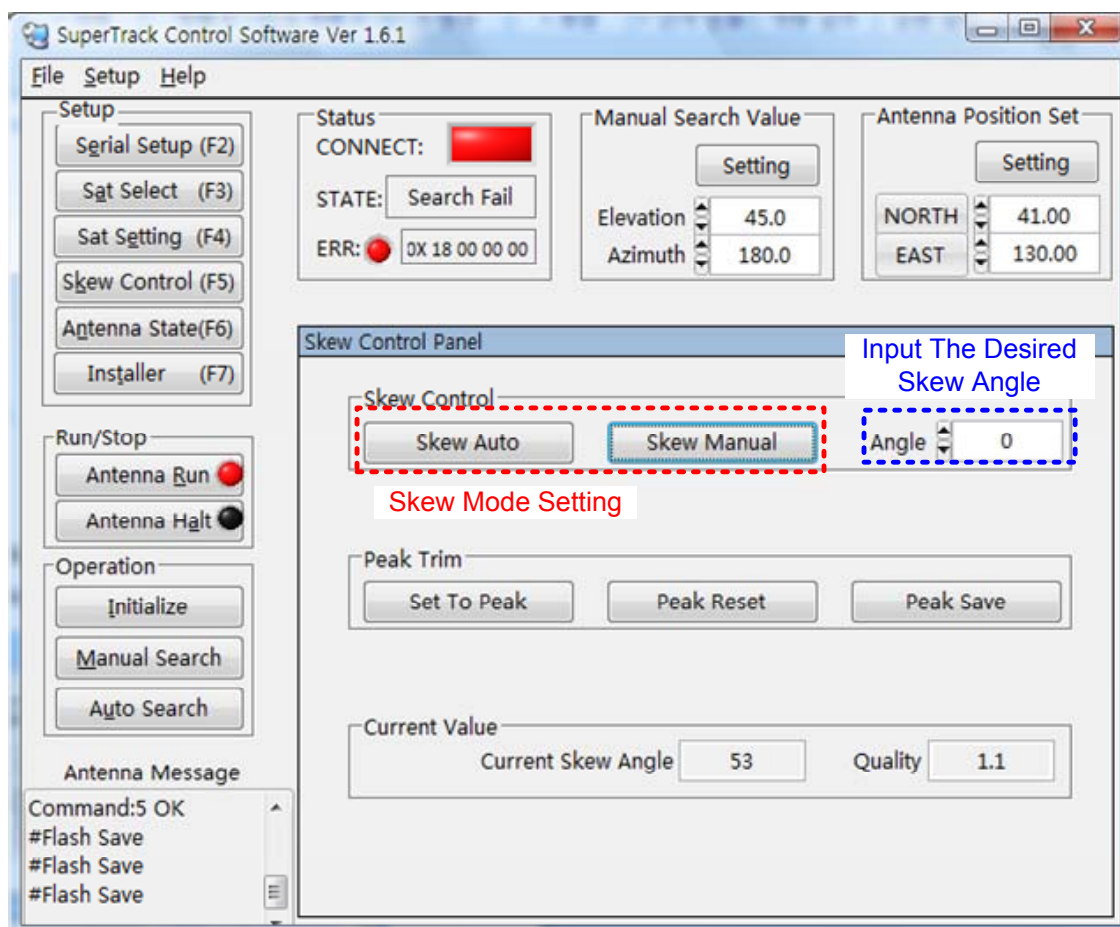

**Figure 4-5 Changing the Skew Angle by Manual Mode**

**NOTE:** If the S8's skew is in manual mode, the S8's skew will not be changed when switching the satellite or changing the ship's position (longitude, latitude). The skew mode is automatically changed to 'Auto' mode when the ACU power is turned on.



## Set the peak trim

The skew angle is automatically calculated by the PCU, but sometimes the satellite has an offset skew angle. In such a case, you have to set the peak to track a higher quality of carrier. Refer to the steps outlined below and to Figure 4-6.

- Change the skew angle using the skew manual mode after selecting the desired satellite whose skew is offset.
- Look at Quality, then search for higher quality while changing the skew angle.
- Click 'Set To Peak', after searching for higher quality.
- Click "Peak Save" to save the changed peak.
- Then, the S8's skew will move to the changed skew angle upon selecting this satellite.

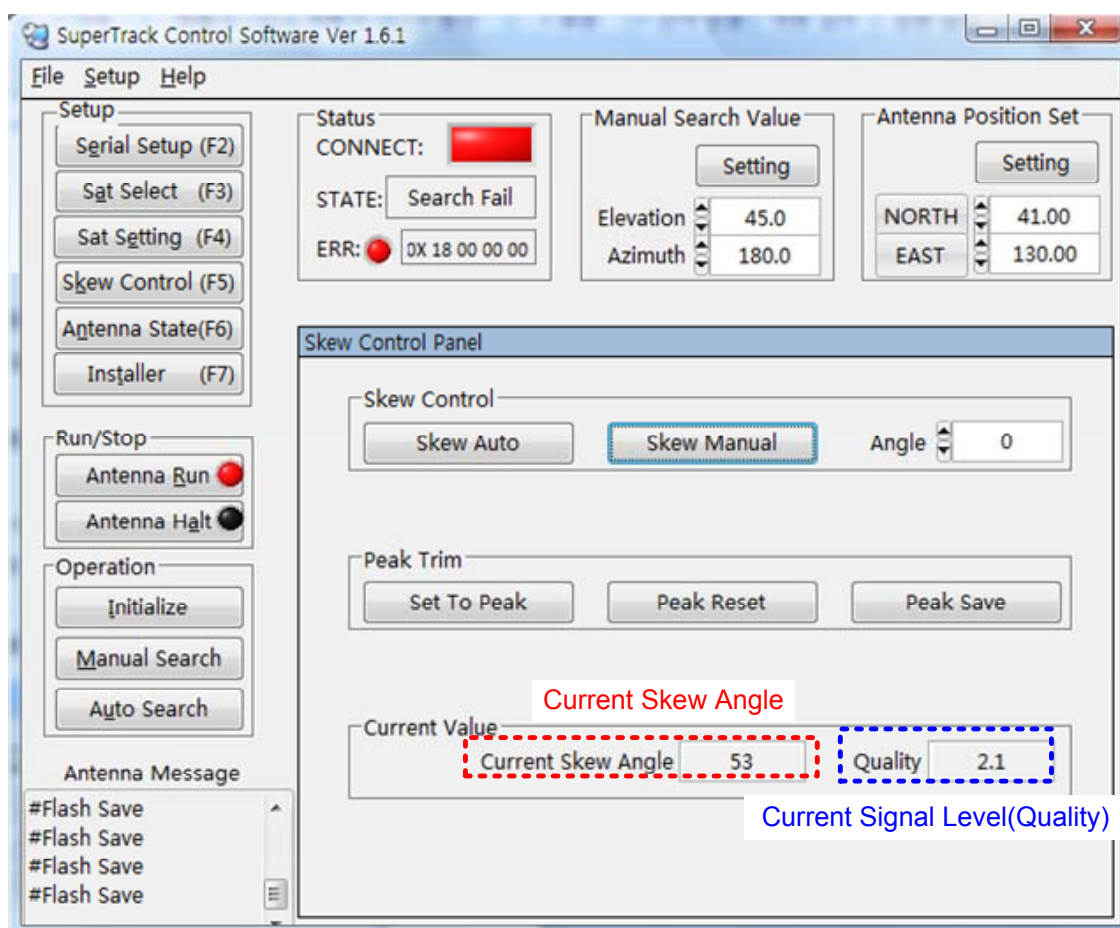

**Figure 4-6 Setting the Peak Trim**

**NOTE:** If you want reset the peak, click 'Peak Reset' and then click 'Peak Save', whereupon all peaks will be reset to the default skew angle.



### 4.4. Antenna State

You can see the current state of the S8 by SCS, as shown below. Click 'Antenna State' or press F6.

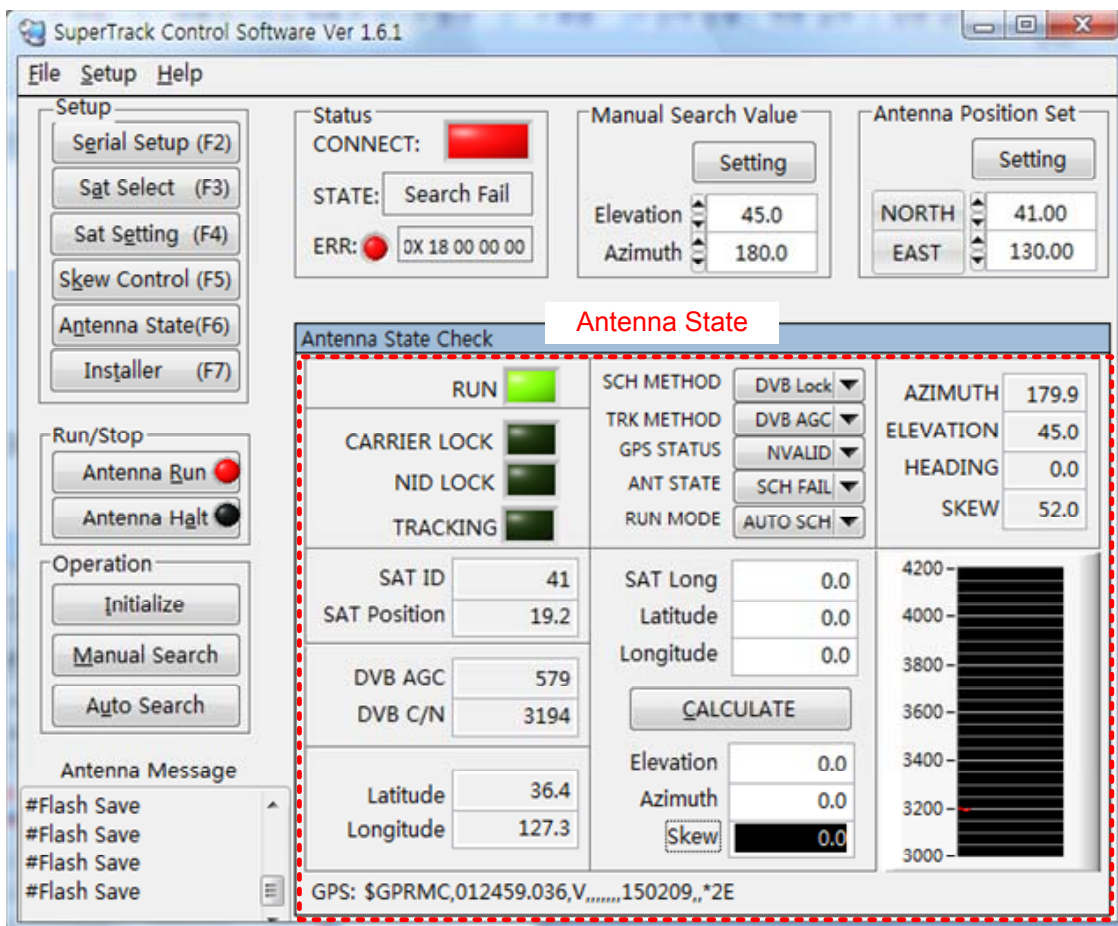

Figure 4-7 Antenna State

## Calculating the Skew Angle, Elevation and Azimuth of the Antenna

You can use SCS to calculate the skew angle, elevation and azimuth of the antenna, if you know the longitude of the satellite and the latitude and longitude of the current position. Refer to the steps outlined below.

- Input the longitude of the satellite, and the latitude and longitude of the current position.
- Click 'CALCULATE' to calculate.
- You can see the calculated value in 'CALCULATE' below.

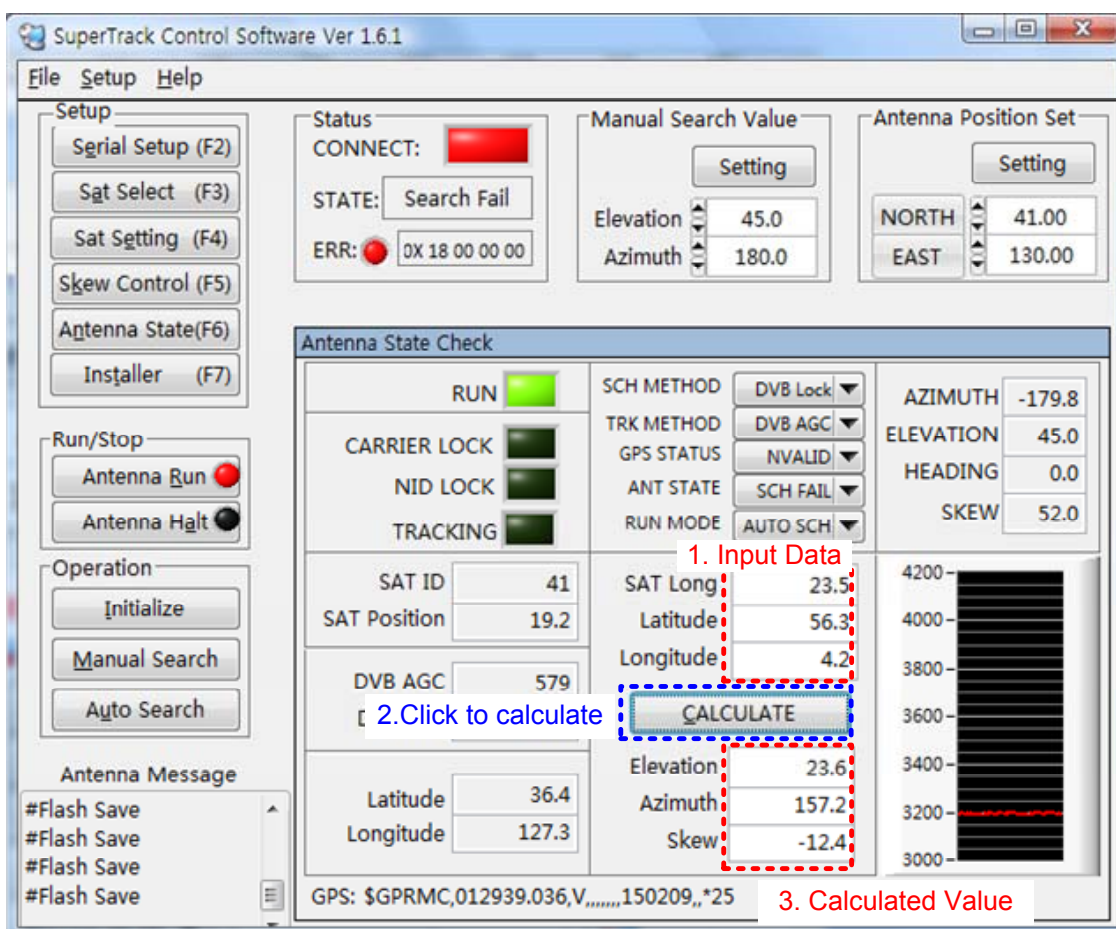

Figure 4-8 Calculating the Skew Angle, Elevation and Azimuth of the Antenna

## C/N Graph

You can see the C/N graph under 'Antenna State'.

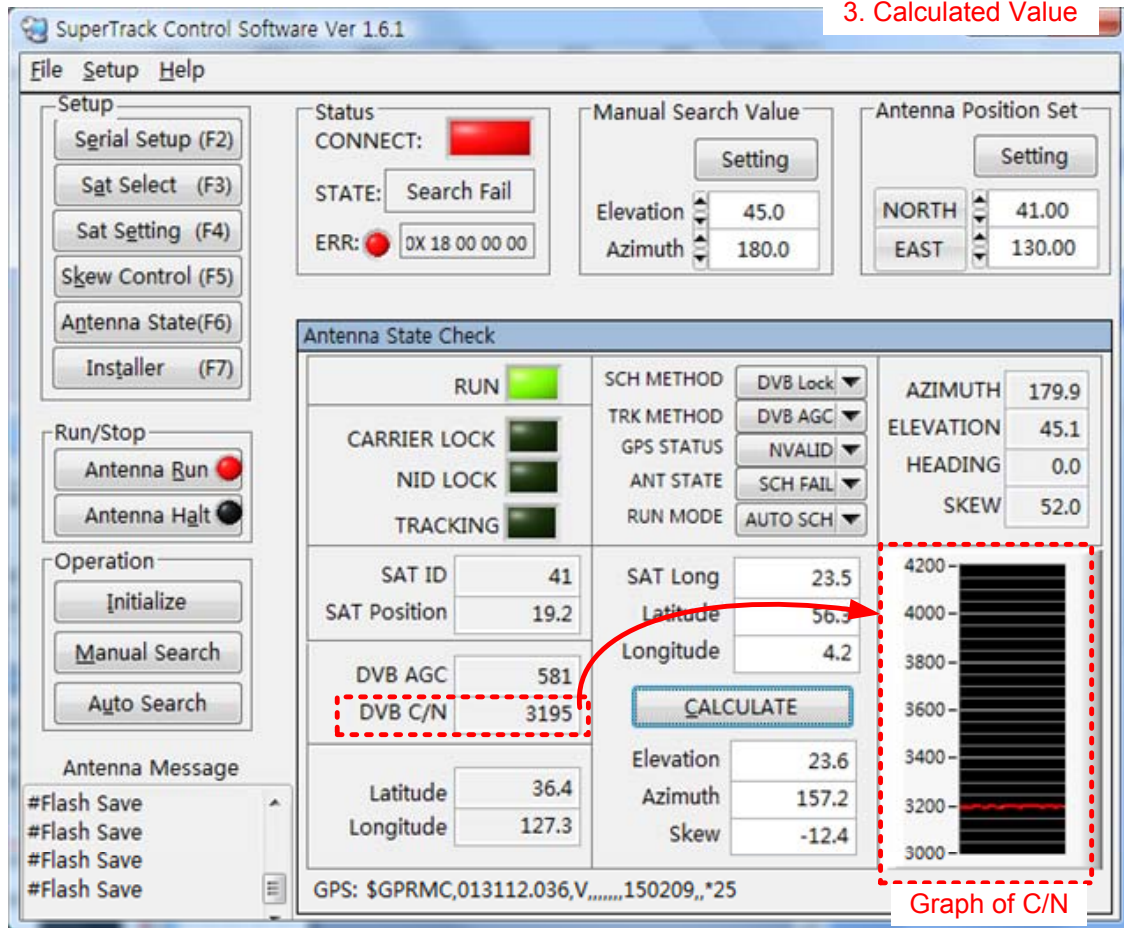

Figure 4-9 C/N Graph

## 4.5. Installer

The installer or operator can change the initial parameters (tilt offset, heading offset, skew zero setting, compass mode) when replacing the PCU, skew block or sensor board.

Click 'Installer' or press F7.

**NOTE:** After changing the initial values (tilt offset, heading offset, skew '0' degree position), you must click 'SAVE' to save to the PCU.

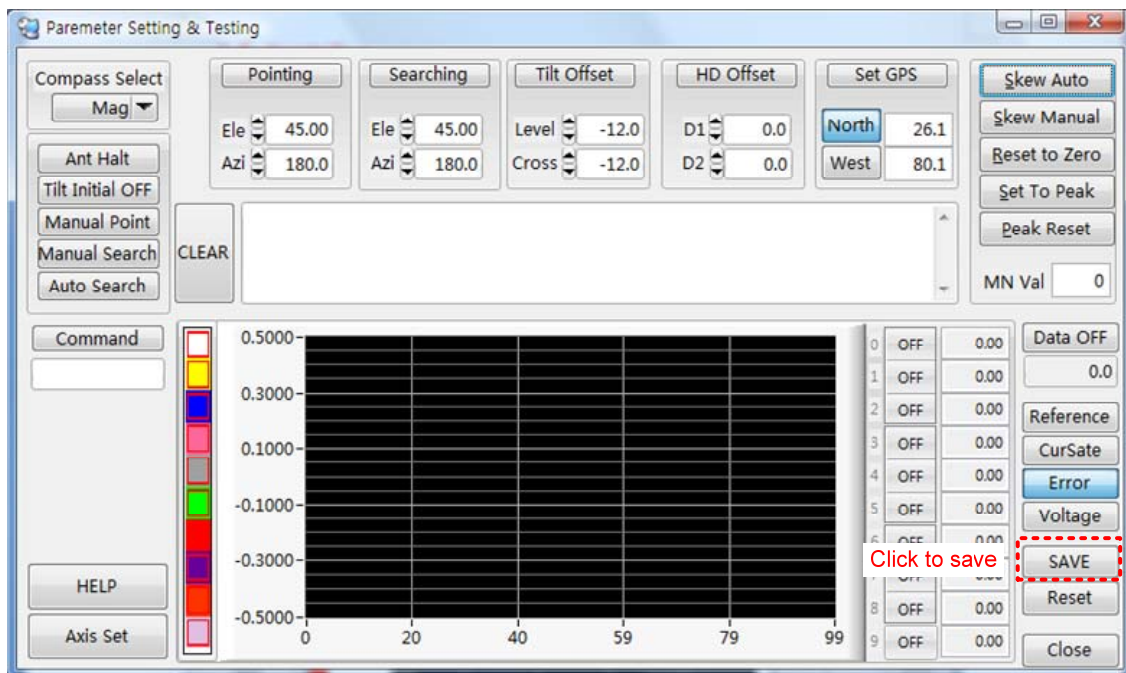

**Figure 4-10 Saving the Initial Values**

### Setting Tilt Offset

You have to re-configure the tilt offset after replacing the PCU or sensor board. When setting the tilt offset, use the bubble inclinometer mounted on the sensor cage, as shown in Figure 4-11.

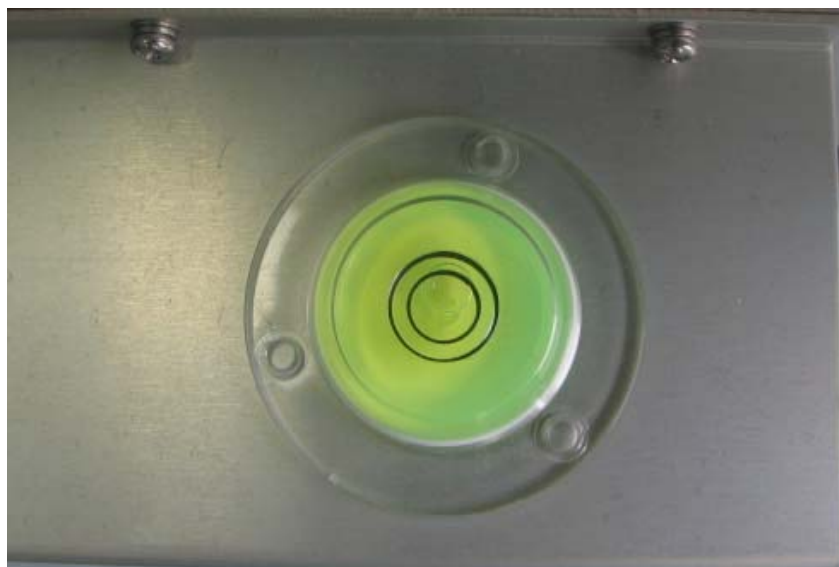
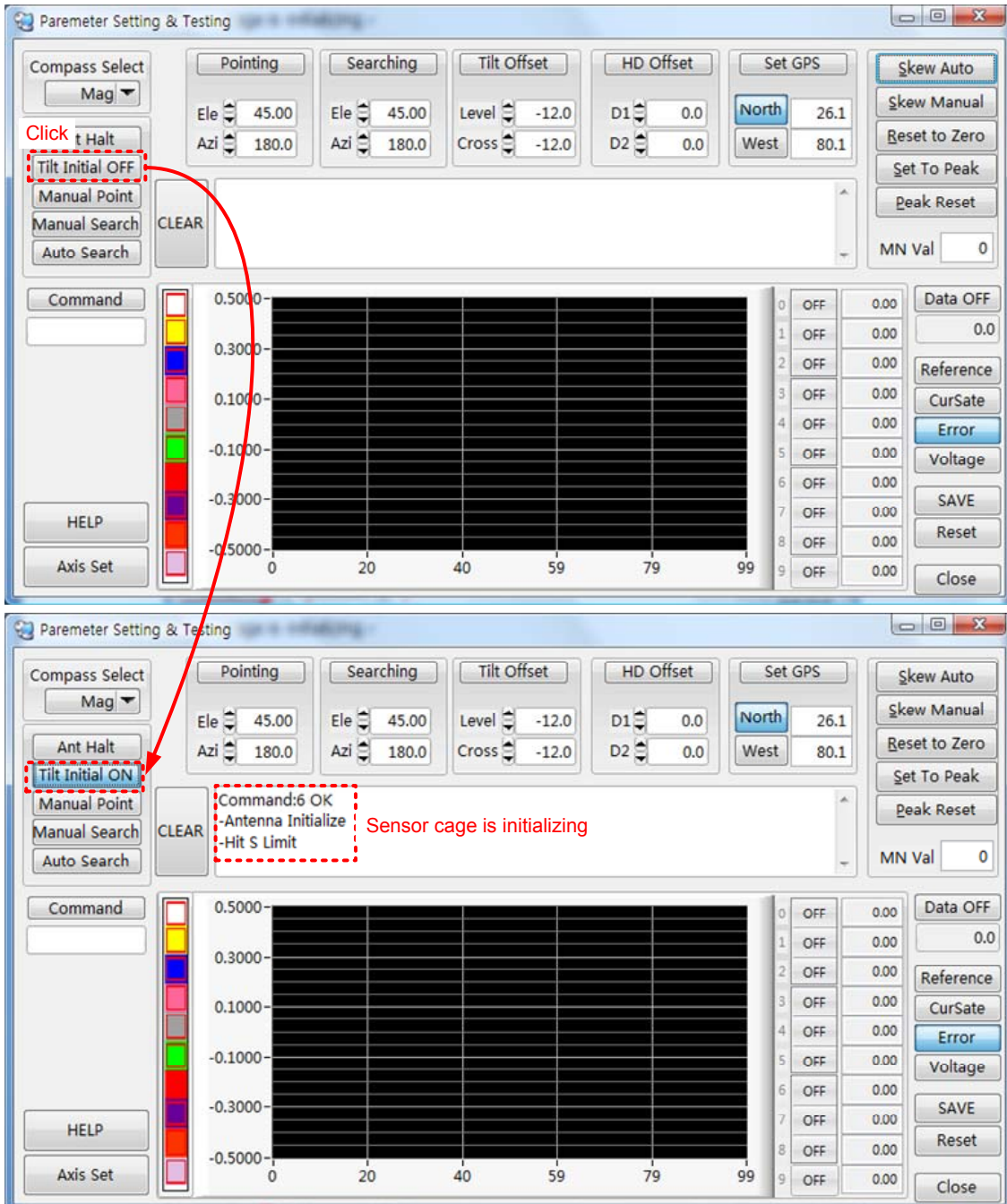

**Figure 4-11 *Bubble Inclinometer***



Refer to the steps outlined below.

- a. Click 'Tilt Initial OFF', then the button changes to 'Tilt Initial ON' and the sensor cage initializes. Then, the antenna points toward the current position, but the yaw axis is free.



**Figure 4-12 Starting Adjustment of Tilt Offset**

- b. Click 'Command' to request the current tilt sensor offset from the PCU after inputting the 'Ibd'.

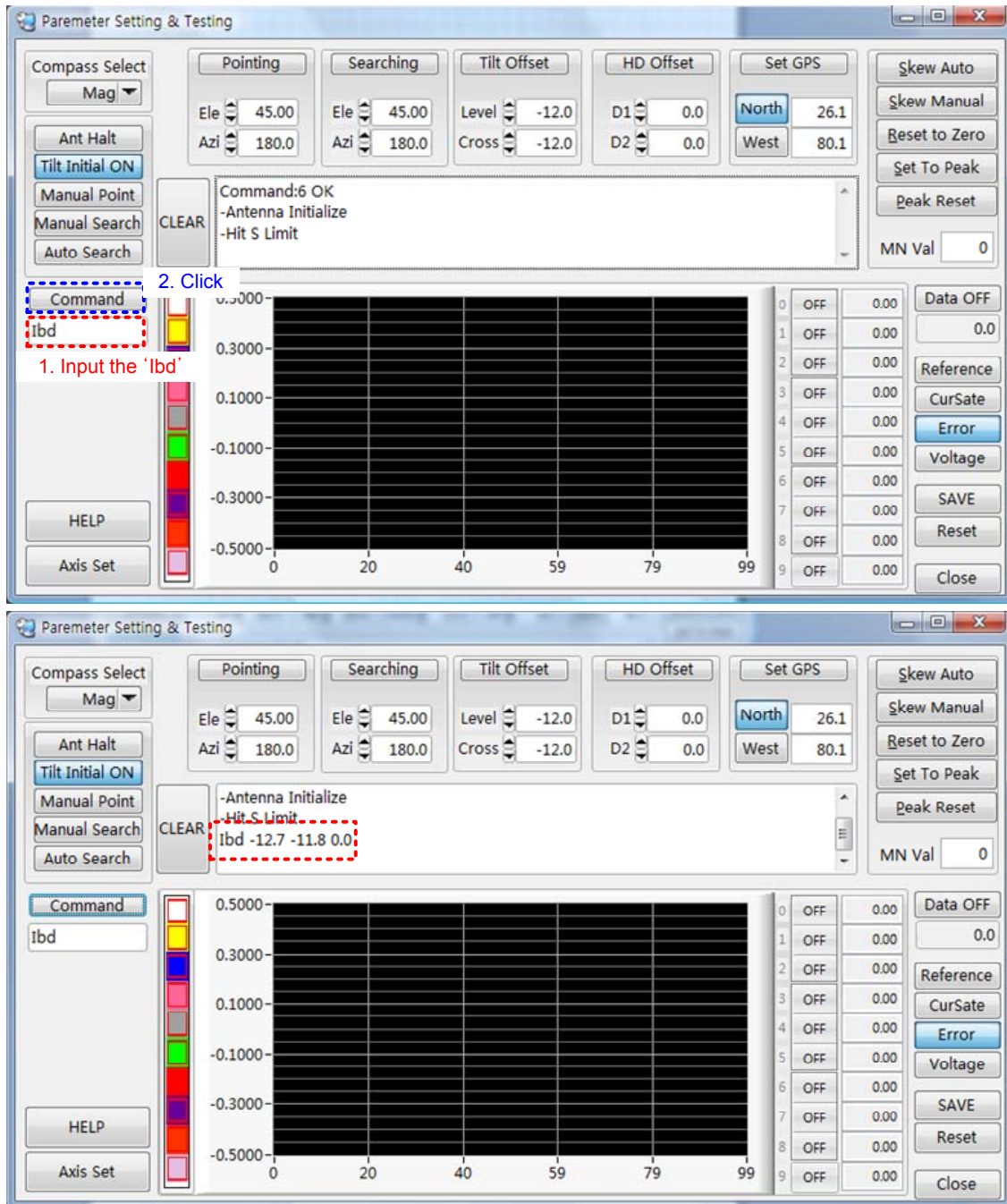

**Figure 4-13 Requesting the Current Tilt Offset**

**NOTE:** 'Ibd' refers to the command current tilt offset requested from the PCU. 'I' is capital letter.

- c. Change the tilt offset of level and cross axis to place the bubble of the bubble inclinometer in the center
- d. Click 'Tilt Offset' to upload to the PCU.

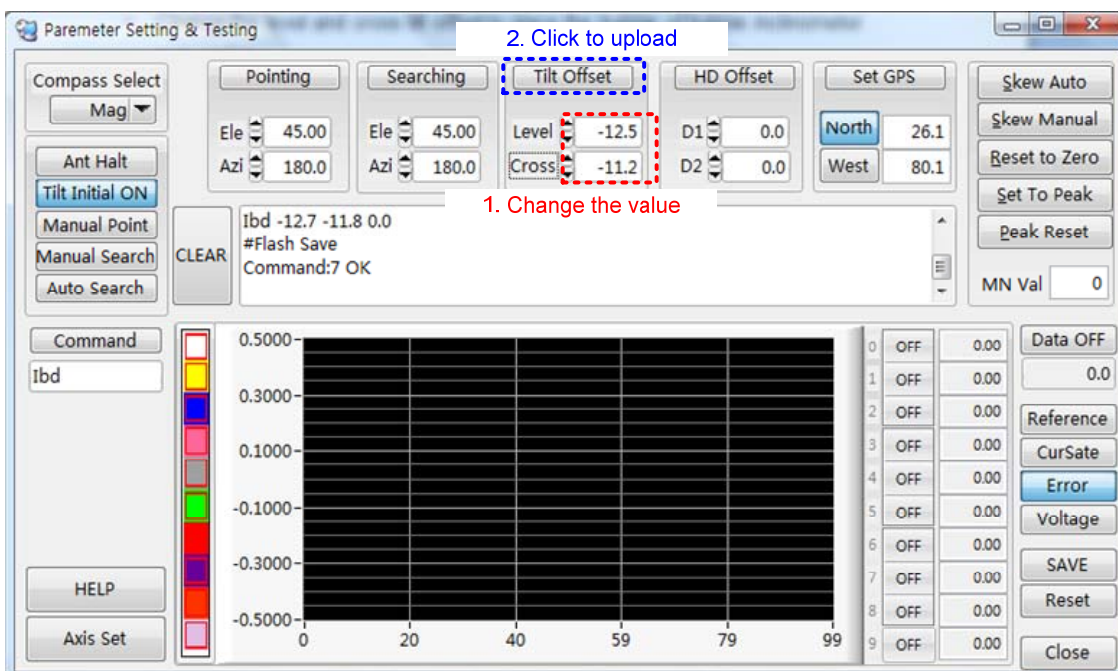

**Figure 4-14 Edit the Tilt Offset**

- e. If the tilt offset is correct, click 'Tilt Initial OFF', whereupon the antenna will start initializing.

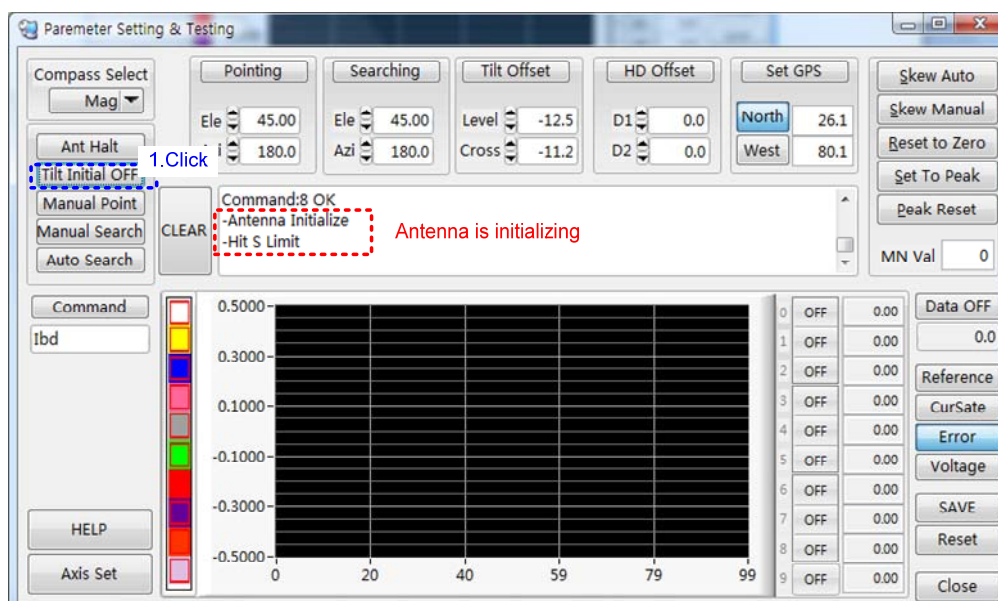
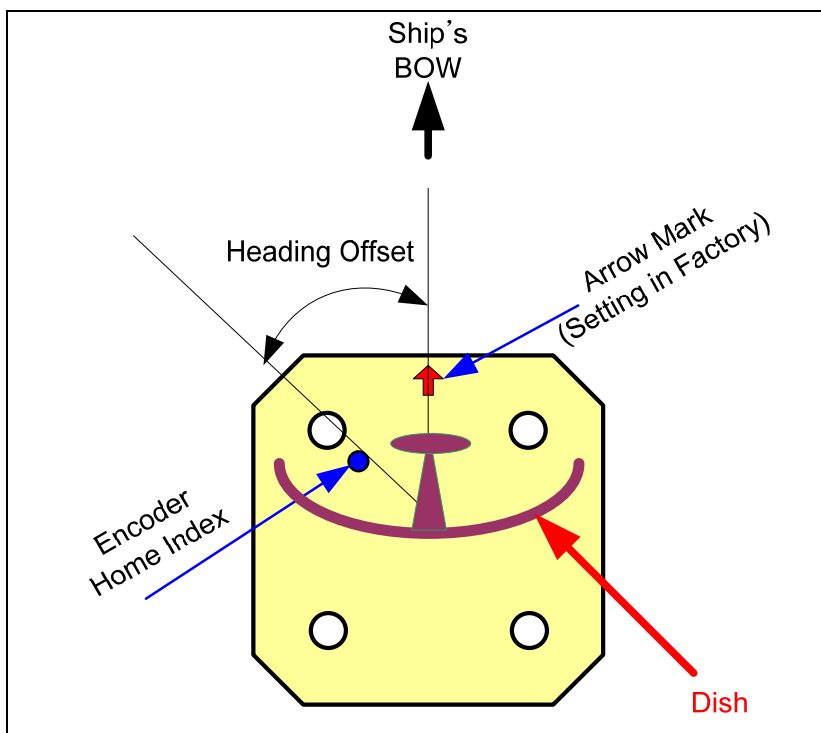

**Figure 4-15 Request the Current Tilt Offset Using the 'Ibd' Command**



## Setting the Heading Offset

'Heading offset' refers to the angle between the encoder home index (the Z pulse position of the encoder) and the set position (i.e. arrow mark on the base plate of the S8). 'S8 search for the satellite' refers to the ship's gyro, so the heading offset must be correct (except when using the internal magnetic sensor).



**Figure 4-16 Initial Heading Offset**

The bow mark of the S8's radome base must be aligned with the ship's bow. If it is not correctly aligned, you must readjust the new heading offset. Refer to the steps outlined below.

- a. Input the desired heading offset in 'D1 box'.
- b. Click 'HD Offset'.
- c. Confirm the new heading offset.

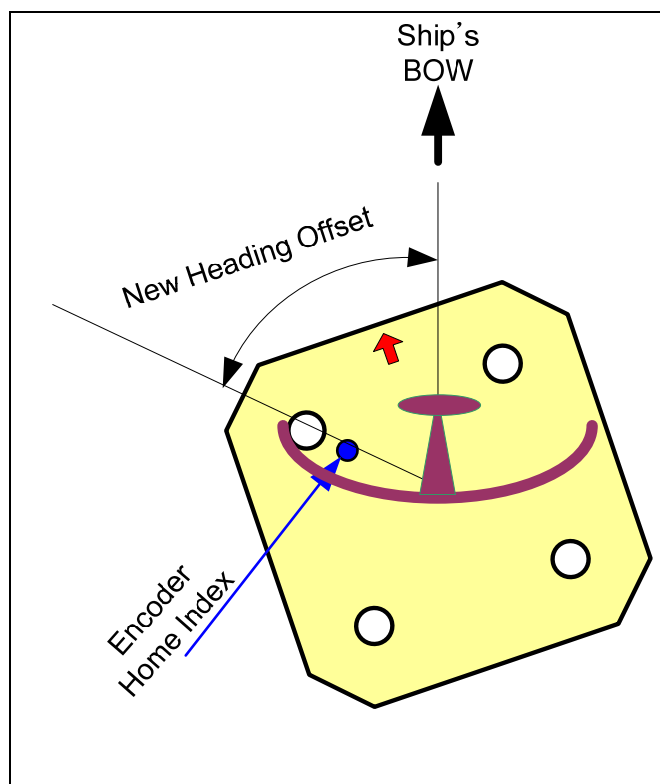

**Figure 4-17 New Heading Offset**

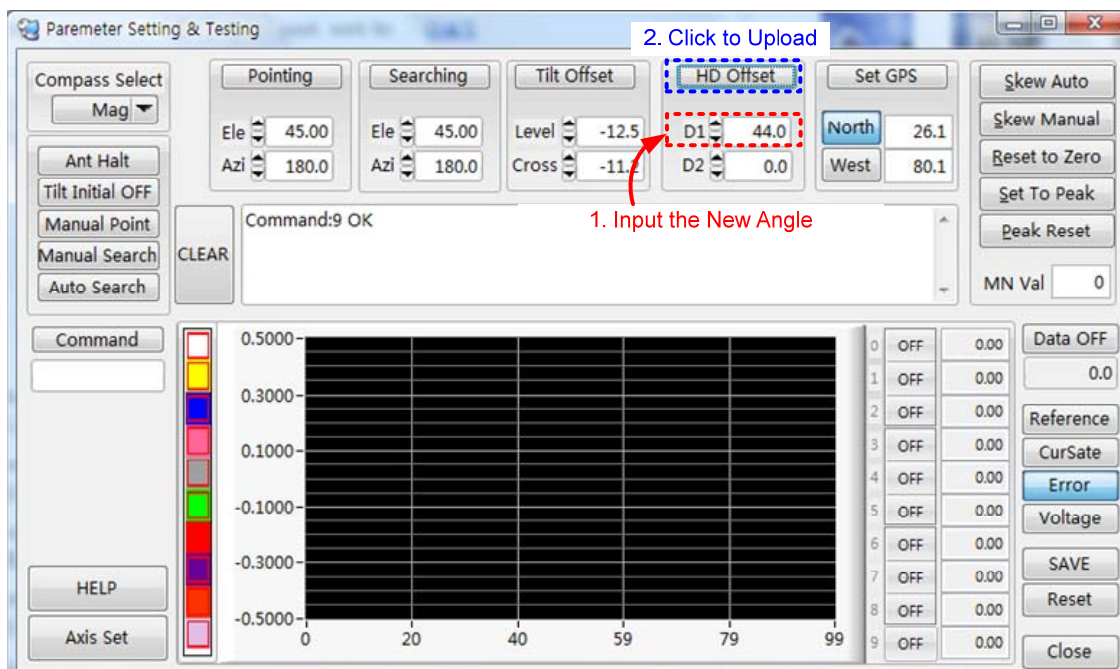

**Figure 4-18 Setting the New Heading Offset**

**NOTE:** When setting the heading offset, the feed has to be directed in the desired direction

## Skew Setting

After replacing the PCU or skew assembly, you must reset the skew '0' degrees position. Refer to the steps outlined below.

- Input the desired new skew angle in the manual value box.
- Click 'Skew Manual', whereupon the skew will move to the desired position.
- Confirm the new skew '0' degrees position.
- If it is correct, click 'Reset to Zero', or, if it is incorrect, re-try the steps outlined above.

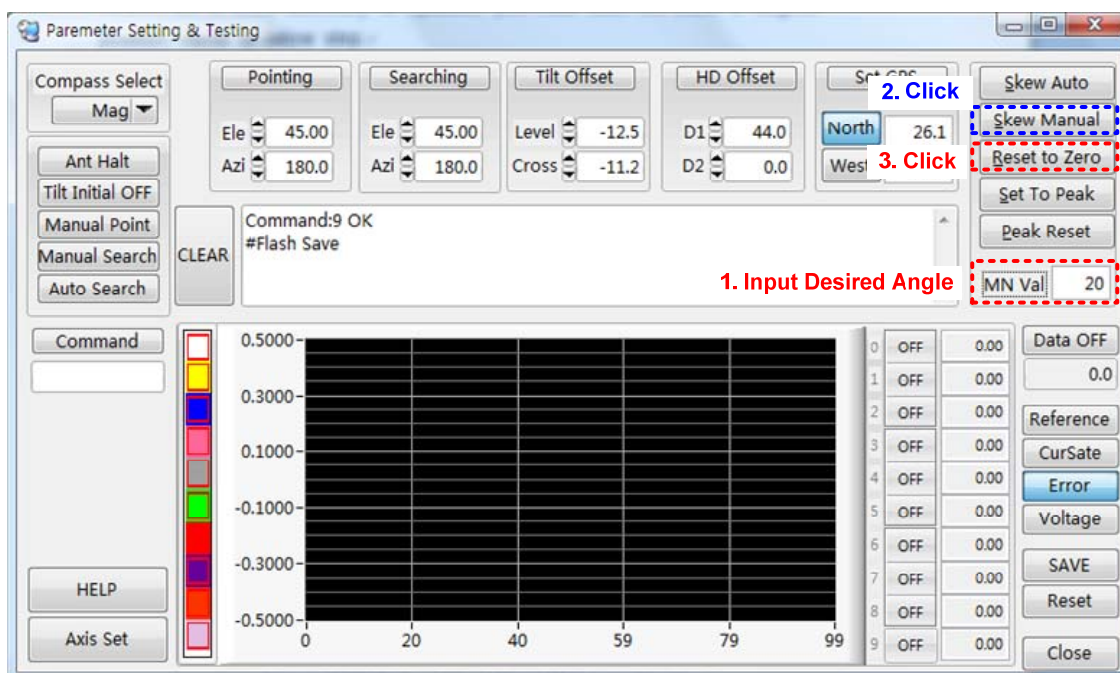

**Figure 4-19 Setting the New Skew '0' degrees Position**

**NOTE:** The '0' degrees position should be aligned with the top side of the LNB using a cross pulley.

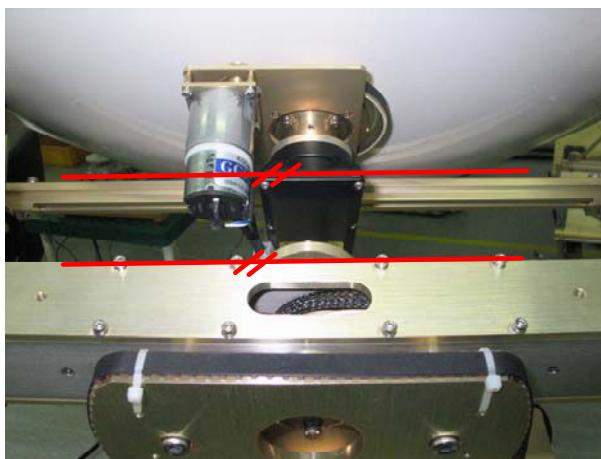

**Figure 4-20** *Setting the New Heading Offset*

**NOTE:** The skew angle range of the S8 is within  $\pm 110^\circ$ . If the skew angle is out of range, the skew will not move. In this case, click 'Reset to Zero' to change the current position to '0' degrees, whereupon the skew will be able to move.

## Compass Mode

When a change of compass mode is required, you can select the compass mode by SCS. First, input 'Zb' at the bottom of the 'Command' button and click 'Command' to request the current compass mode from the PCU. Then, you can check the current compass mode. The S8 has the following 4 compass modes: (Gyro(Zba), Internal Magnetic (Zbb), Gyro Fail (Zbc), and Internal Magnetic Fail (Zbd). Second, select the compass mode after clicking '▼', whereupon the changed compass mode will be uploaded to the PCU. The S8 will initialize and the compass mode will be changed upon selecting the compass mode.

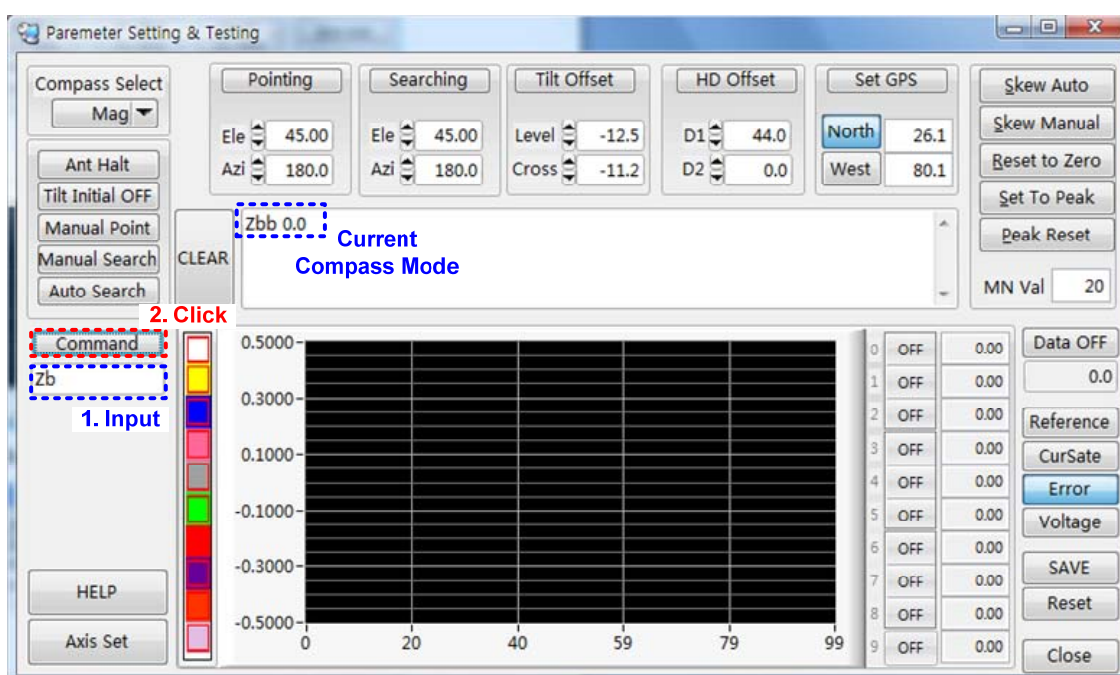
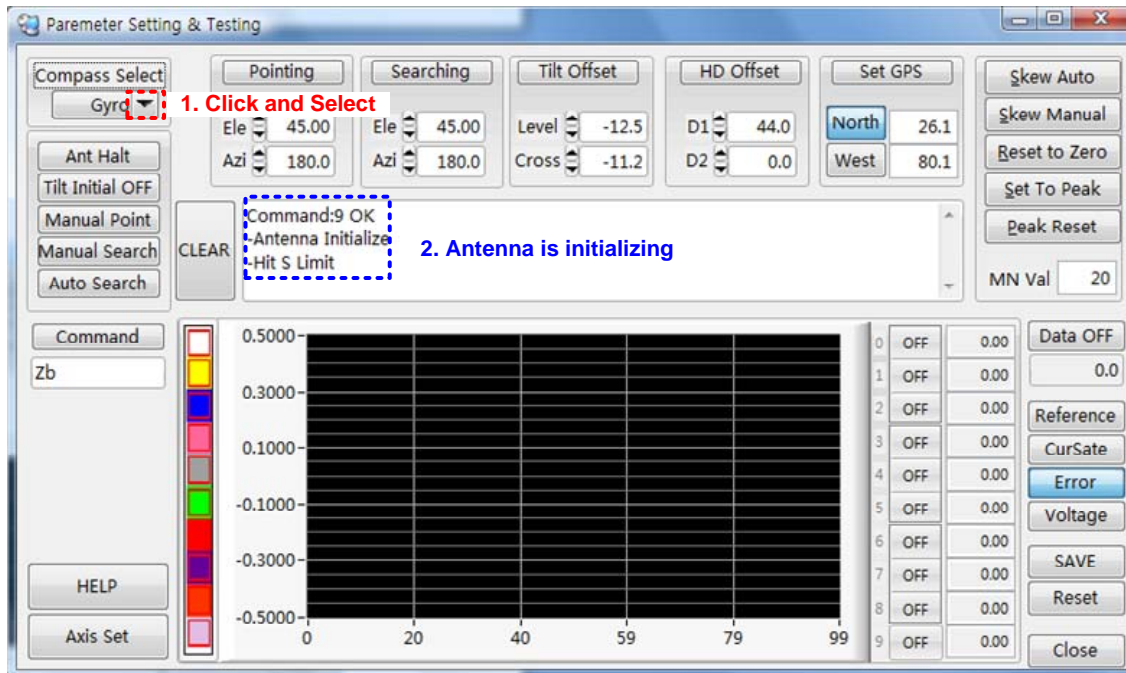

Figure 4-21 Requesting the Current Compass Mode



**Figure 4-22 Setting the Compass Mode**

## Set GPS

SCS sets the GPS data when the GPS data is invalid or when GPS fails.

- Input the latitude and longitude.
- If changing 'North' or 'South' and 'East' or 'West', click 'North' or 'South' and 'East' or 'West'
- Click 'Set GPS'

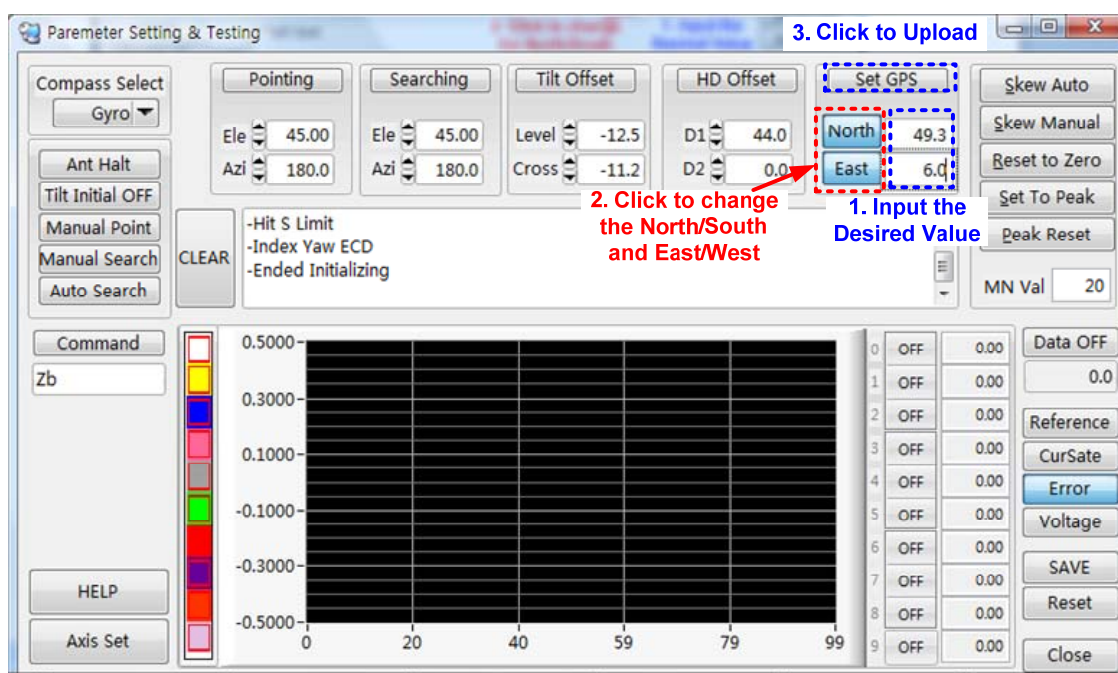

Figure 4-23 Setting the GPS Data



## Graph

You can see the graph showing the antenna's parameters by SCS. Refer to the steps outlined below.

- Select an item ('Reference', 'CurSate', 'Error', 'Voltage').
- Select from the sub-menus(1~9), and then click the 'on' button of the selected sub-menus.
- Click "Axis Set" to set the axis, and then change the maximum and minimum values of the graph.
- Click 'Data OFF' to see the graph.
- Click 'Data ON' to stop display of the graph.

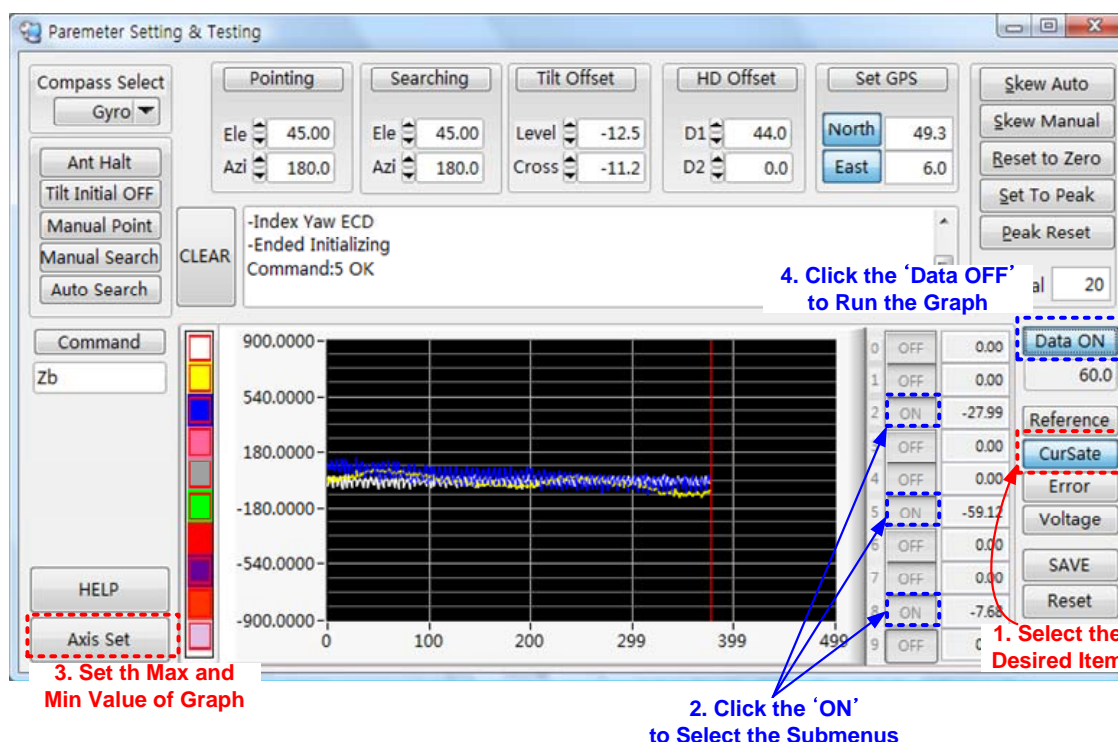

**Figure 4-24 View of the Graph**

NOTE: Click the 'HELP' button to see the index of the graph.



## Appendix A: Example of Setting the Satellite's Parameters Using SCS

The S8 has 80 satellite parameters. You can input or change the satellite parameters if there is no desired satellite.

If you want to input the desired satellite parameters in User 1, please follow the steps outlined below.

Satellite	Longitude	RF Frequency	Symbol Rate	Polarity
User1	E23.5	10,803MHz	22,000KHz	Horizontal

Table A-1 Default Satellite Parameters in User 1

Satellite	Longitude	RF Frequency	Symbol Rate	Polarity
Astra2Connect	E13	12,437MHz	27,500KHz	Horizontal

Table A-2 Desired Satellite Parameters

1. Connect the ACU with the PC, and press and hold 'M/C' on the front panel of the ACU for 2~3 seconds.
2. Run SCS Ver. 1.6.1.
3. Click 'DISCONNECT'.

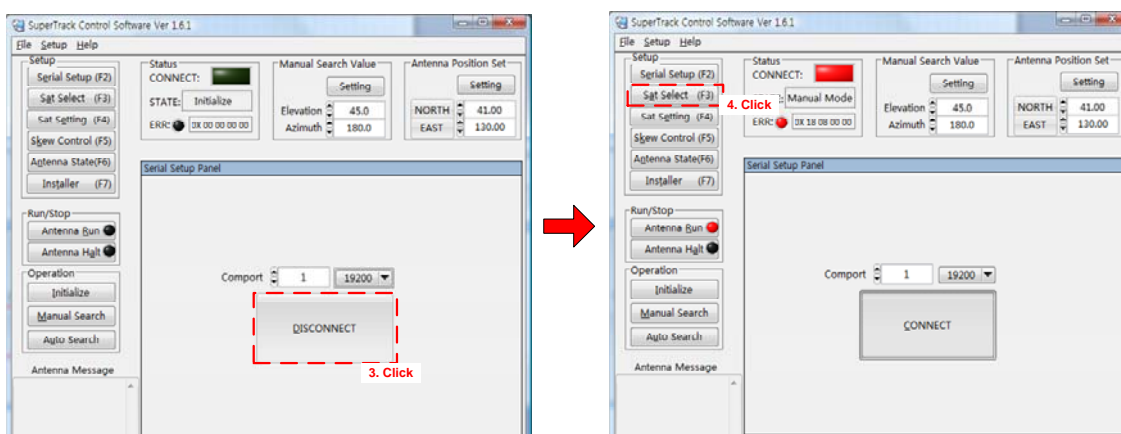

4. Click 'Sat Select' or press F3.
5. Select EUROPE in 'Zone Select'.
6. Select '(S:59)023.5E Astra2ConHigh/User1' in 'Satellite Select'.
7. Click 'Send' to upload to the PCU.

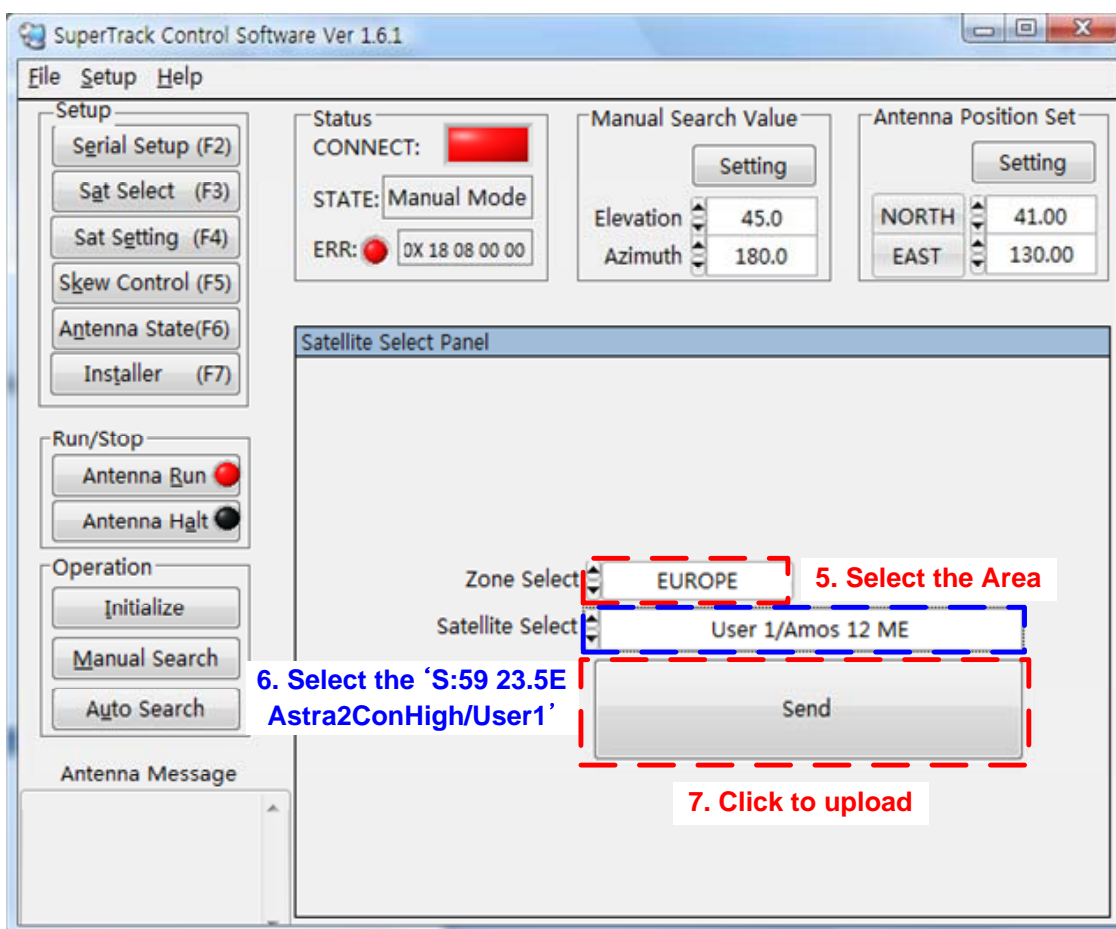

8. Click 'Sat Setting' or press F4.
9. Click 'Zone Info Request' and 'Sat Info Request' to request the default satellite's parameters, then the Sat ID 58 satellite parameters can be updated in the 'Satellite Setting' panel.

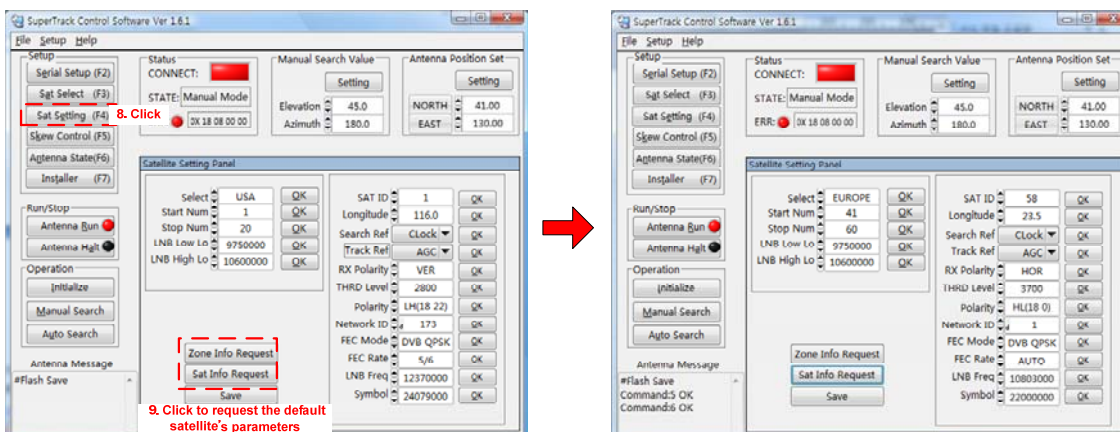

10. Change 'Longitude', 'LNB Freq' and 'Symbol', as shown in the Figure below.
11. Click 'OK' on the right-hand side of the changed parameters to upload to the PCU.

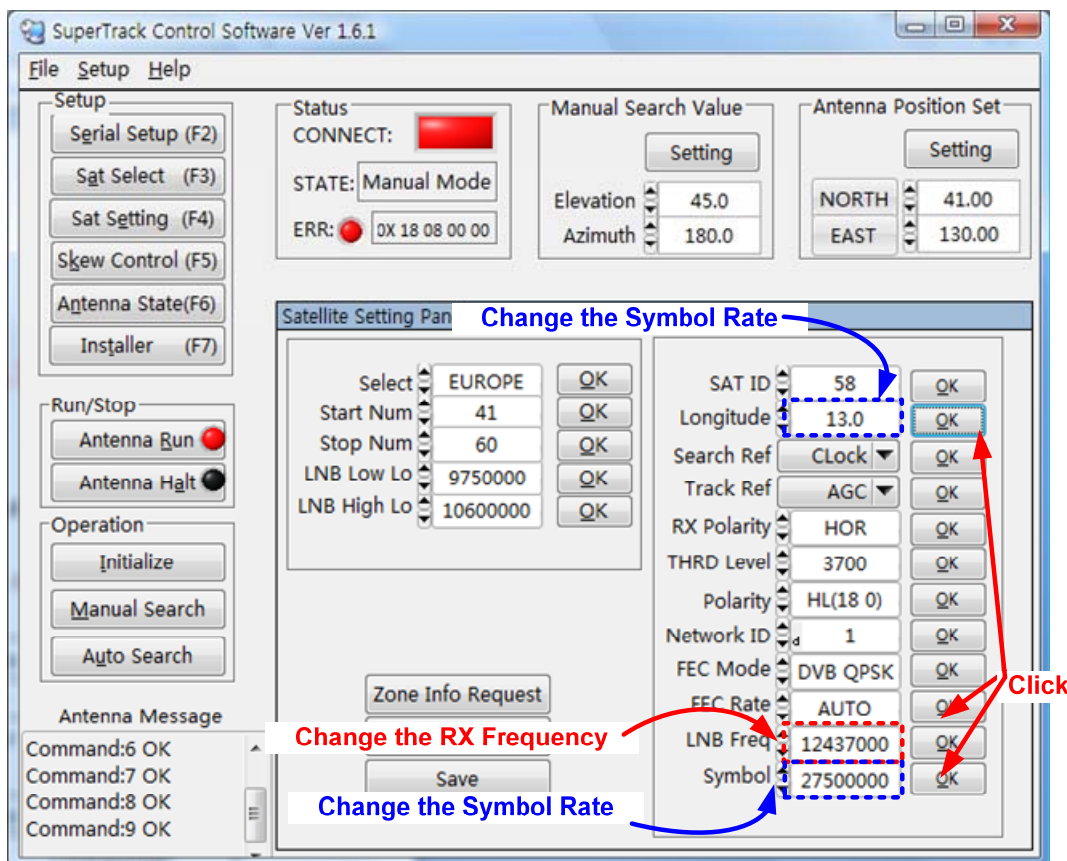

12. Click 'SAVE' to save to the PCU. Then you will be able to see the return message from the PCU.

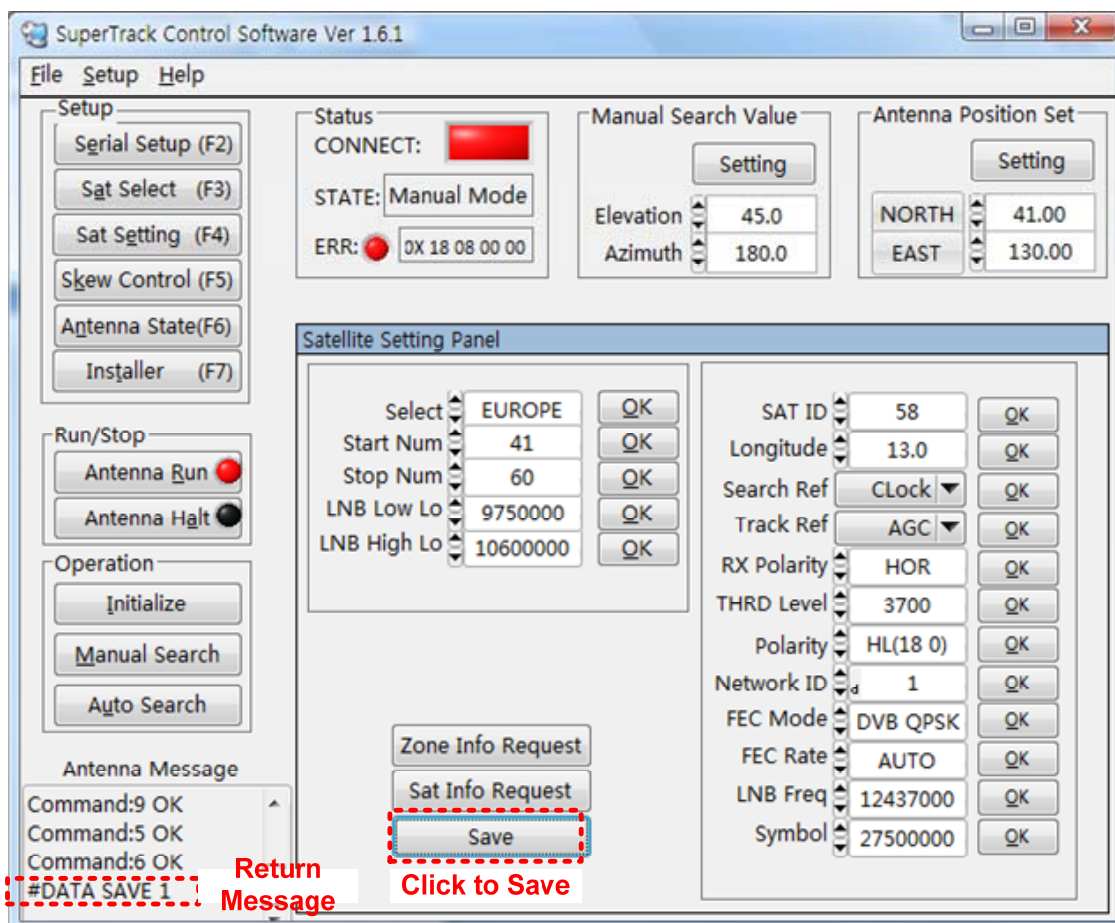

13. Click 'Auto Search' to search for the satellite.

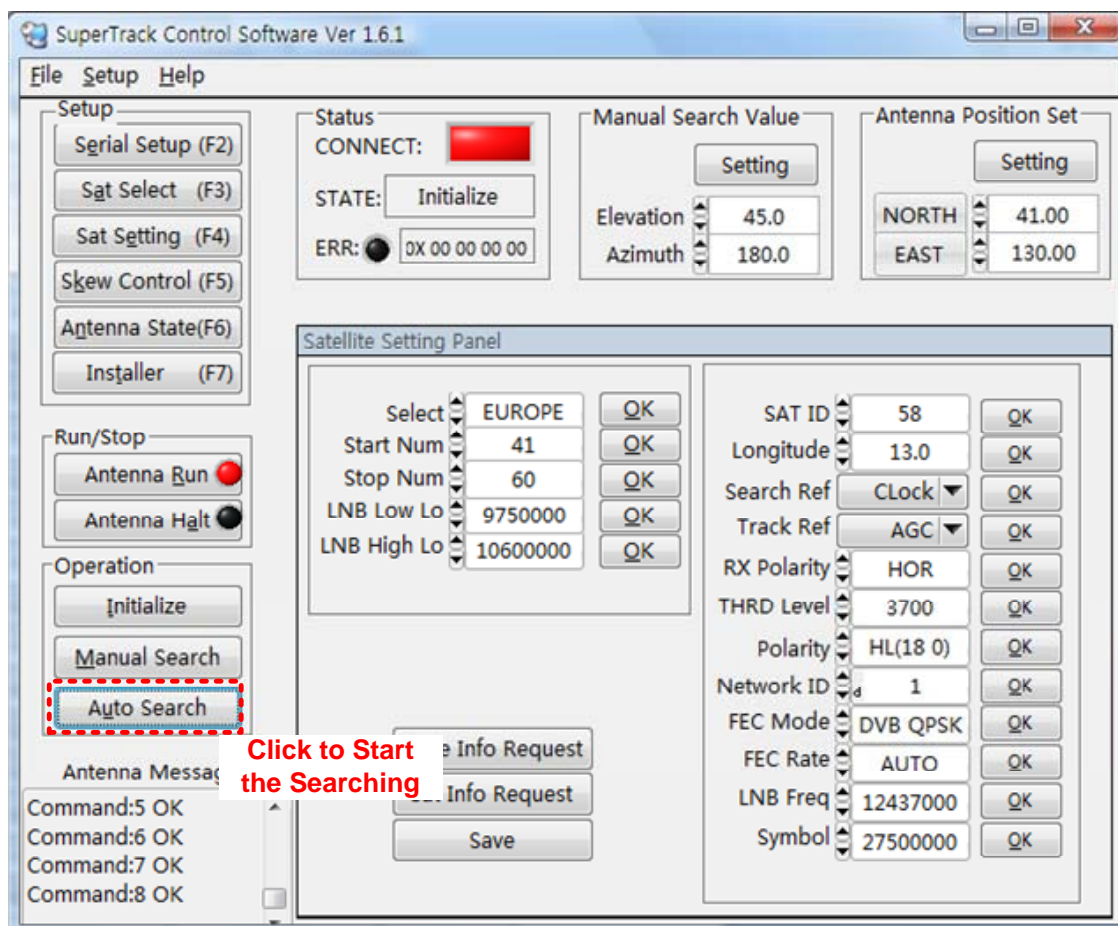

Then, the S8 will search for and track the desired satellite.

## Appendix B: Error Code Definition

If there is a problem with the antenna, you can check the error code on the ACU and SCS. Press the 'MENU' button on the front panel of the ACU when the error LED is on. Then, you will see the hexadecimal error code, as shown in Fig C-1 below.

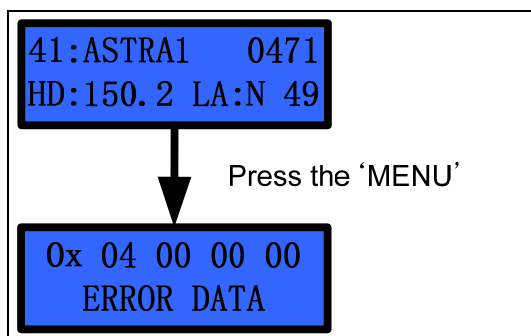

**Figure B-1 Error Code on ACU**

You will also be able to see the hexadecimal error code on the SCS V 1.7.1, as shown in Figure C-2 below.

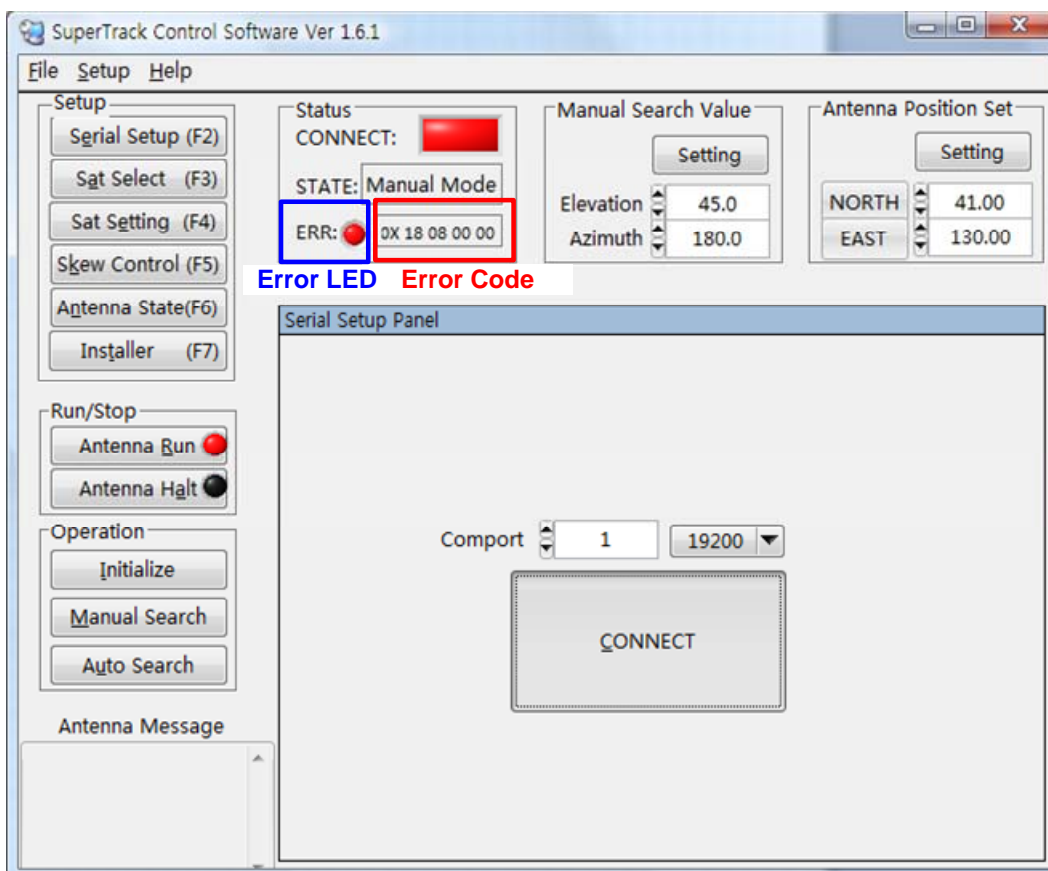

**Figure B-2 Error Code on SCS**



Table C-1 shows the error code definition, but this is a binary code. Thus, you must convert the hexadecimal code to a binary code to confirm the error.

EX 1) Hexadecimal error code: '0X 18 08 00 00'

Convert to binary error code: 0X 00011000 00001000 00000000 00000000

- ⇒ 1<sub>5</sub> error of FF<sup>(1)</sup> means that the satellite information is not acceptable (i.e. the satellite longitude or current antenna latitude and longitude information is not acceptable).
- ⇒ 1<sub>4</sub> error of FF<sup>(1)</sup> refers to indicate that GPS fails in receiving in time (when GPS normally receives the signal, the error message disappears)
- ⇒ 1<sub>4</sub> error of FF<sup>(2)</sup> means that there is no gyro input.

EX 2) The hexadecimal error code: '0X 20 00 00 07'

Convert to the binary error code: 0X 00100000 00000000 00000000 00000111

- ⇒ Error refers to the 7<sup>th</sup> error of the DBS tuner error.

#### Error Code Define

PCU Version: after 1.94

Syntax: 0x: FF<sup>(1)</sup> FF<sup>(2)</sup> FF<sup>(3)</sup> FF<sup>(4)</sup>

0x FF<sup>(1)</sup> = 1<sub>8</sub>1<sub>7</sub>1<sub>6</sub>1<sub>5</sub> 1<sub>4</sub>1<sub>3</sub>1<sub>2</sub>1<sub>1</sub>

- 1<sub>1</sub>: Level motor driving error (clear if it returns to normal state in time)
- 1<sub>2</sub>: Cross motor driving error (clear if it returns to normal state in time)
- 1<sub>3</sub>: Yaw motor driving error (clear if it returns to normal state in time)
- 1<sub>4</sub>: GPS non valid error in time (clear if it returns to valid)
- 1<sub>5</sub>: Satellite information is not acceptable (satellite longitude or current antenna latitude, longitude information)(clear if in normal state)
- 1<sub>6</sub>: DBS tuner error
- 1<sub>7</sub>: The stopper is not recognized during initialization
- 1<sub>8</sub>: Not used

0x FF<sup>(2)</sup> = 1<sub>8</sub>1<sub>7</sub>1<sub>6</sub>1<sub>5</sub> 1<sub>4</sub>1<sub>3</sub>1<sub>2</sub>1<sub>1</sub>

- 1<sub>1</sub>: Home Index during initialization

- 1<sub>2</sub>: There is an unknown satellite (when the NID lock is used for searching)
- 1<sub>3</sub>: Searching fail (clear if in normal state)
- 1<sub>4</sub>: No gyro input (refers to a communication error)(clear if in normal state)
- 1<sub>5</sub>: PCU DSP flash writing error
- 1<sub>6</sub>: PCU DSP EEPROM writing error
- 1<sub>7</sub>: Not used
- 1<sub>8</sub>: Not used

0x FF<sup>(3)</sup> = 1<sub>8</sub>1<sub>7</sub>1<sub>6</sub>1<sub>5</sub> 1<sub>4</sub>1<sub>3</sub>1<sub>2</sub>1<sub>1</sub>

- 1<sub>1</sub>: Not used
- 1<sub>2</sub>: Not used
- 1<sub>3</sub>: Not used
- 1<sub>4</sub>: Not used
- 1<sub>5</sub>: Not used
- 1<sub>6</sub>: Not used
- 1<sub>7</sub>: Not used
- 1<sub>8</sub>: Not used

0x FF<sup>(4)</sup>

- 0x01: System has restarted
- 0x02: Unknown RS232 error has occurred
- 0x03: Unknown or invalid command has been received
- 0x04: Unknown or invalid data has been received.
- 0x05: The 'TS:' command must be sent prior to the command.  
This is for programming the transponder/satellite data.
- 0x06: A tuner I2C bus failure has occurred. This could indicate that the tuner is defective.
- 0x07: The LNB polarity voltage is not within the LNB polarity range. This could indicate that the LNB voltage does not change or that the LNB voltage has shorted.
- 0x08: The LNB signal level is below the valid range. This could indicate that the LNB is not connected.
- 0x09: The E2Ram has failed

**Table C-1 Error Code Definition**

**NOTE:** To clear the error by perforce after checking the error, press the 'NEXT' button on the ACU. If using the SCS, click the 'ERR' LED.



## Appendix C: Specifications

Above Deck			
<b>Antenna Dish Diameter</b>	85cm (33")	<b>Antenna Dimensions</b>	110cm(H) x 103cm(D)
<b>Antenna Weight</b>	57Kg	<b>Radome Material</b>	FRP
<b>Minimum EIRP</b>	42 dBW	<b>Azimuth Range</b>	640°
<b>Skew Control</b>	Automatic (-110° ~ +110° )	<b>LNB</b>	Quad / Quattro
<b>Cross Angle</b>	+/- 35°	<b>Tracking Speed</b>	More than 90°/ sec
<b>Platform</b>	3-axis	<b>Elevation Angle</b>	-10° to +100°
<b>GPS</b>	Yes	<b>Encoder</b>	Yes
<b>Vibration Damper</b>	Rubber Damper	<b>DiSEqC</b>	DiSEqC 1.2
<b>Temperature</b>	-25°C to +55°C	<b>Humidity</b>	Up to 100% @ 40°C
Below Deck			
<b>ACU Size</b>	218 x 158 x 50mm	<b>External I/O</b>	RS232C
<b>Input Power</b>	110/220 VAC	<b>Gyro Compass Input</b>	NMEA (Option)
<b>Output Power</b>	24VDC 60W		
Packing			
<b>Size</b>	125 x 125 x 147cm	<b>Gross Weight</b>	150kg
<b>Packed by</b>	Wooden Crate		

## Appendix D: Satellite Information

### North America

Sat ID	Satellite Longitude	Satellite Name	Polarity & LO Band	NI D	FEC Mode	FEC Rate	Frequency (KHz)	Symbol Rate(KHz)	Beam
01	061.5-W	EchoStar3	HH	0	DVBQ	Auto	12,574,000	21,500,000	Conus
02	072.5-W	DirecTV 1	RH	0	DVBQ	Auto	12,239,000	20,000,000	
03	082.0-W	Nimiq 4	RH	0	DVBQ	Auto	12,428,000	20,000,000	
04	091.0-W	Nimiq 1	RH	0	DVBQ	Auto	12,341,000	20,000,000	Canada
05	101.0-W	DirecTV1R	RH	0	DVBQ	Auto	12,224,000	20,000,000	
06	110.0-W	Echo810/Direc 5	RH	0	DVBQ	Auto	12,486,000	20,000,000	-
07	119.0-W	Echo7/Direc 7S	RH	0	DVBQ	Auto	12,370,000	20,000,000	Conus
08	121.0-W	Echostar9	HH	0	DVBQ	Auto	11,972,000	20,000,000	Ku
09	129.0-W	Ciel2	RH	0	DVBQ	Auto	12,457,000	21,500,000	Conus
10	072.0-W	AMC-6	VH	0	DVBQ	Auto	12,148,000	2,573,000	Ku
11	101.0-W	AMC4	HH	0	DVBQ	Auto	12,060,000	26,700,000	North& Central America
12	97.0-W	Galaxy19	HH	0	DVBQ	Auto	12,152,000	20,000,000	North America KU
13	89.0-W	Galaxy28	HH	0	DVBQ	Auto	11,787,000	15,915,000	North America KU
14	101.0-W	User 4	RH	0	DVBQ	Auto	12,224,000	20,000,000	
15	101.0-W	User 5	RH	0	DVBQ	Auto	12,224,000	20,000,000	
16	101.0-W	User 6	RH	0	DVBQ	Auto	12,224,000	20,000,000	
17	101.0-W	User 7	RH	0	DVBQ	Auto	12,224,000	20,000,000	

18	101.0-W	User 8	RH	0	DVBQ	Auto	12,224,000	20,000,000	
19	101.0-W	User 9	RH	0	DVBQ	Auto	12,224,000	20,000,000	
20	101.0-W	User 10	RH	0	DVBQ	Auto	12,224,000	20,000,000	

### South America

Sat ID	Satellite Longitude	Satellite Name	Polarity & LO Band	NI D	FEC Mode	FEC Rate	Frequency (KHz)	Symbol Rate(KHz)	Beam
21	095.0-W	Galaxy3C	LL	0	DSSQ	Auto	11,690,000	20000000	Latin America
22	113.0-W	SatMex6	HH	0	DVBQ	Auto	12,080,000	25,645,000	Ku2
23	058.0-W	Intelsat9	HH	0	DVBQ	Auto	12,160,000	30,000,000	Mexico
24	058.0-W	User 1	HH	0	DVBQ	Auto	11,960,000	30,000,000	Mexico
25	058.0-W	User 2	HH	0	DVBQ	Auto	11,960,000	30,000,000	Mexico
26	058.0-W	User 3	HH	0	DVBQ	Auto	11,960,000	30,000,000	Mexico
27	058.0-W	User 4	HH	0	DVBQ	Auto	11,960,000	30,000,000	Mexico
28	058.0-W	User 5	HH	0	DVBQ	Auto	11,960,000	30,000,000	Mexico
29	058.0-W	User 6	HH	0	DVBQ	Auto	11,960,000	30,000,000	Mexico
30	058.0-W	User 7	HH	0	DVBQ	Auto	11,960,000	30,000,000	Mexico
31	058.0-W	User 8	HH	0	DVBQ	Auto	11,960,000	30,000,000	Mexico
32	058.0-W	User 9	HH	0	DVBQ	Auto	11,960,000	30,000,000	Mexico
33	058.0-W	User 10	HH	0	DVBQ	Auto	11,960,000	30,000,000	Mexico
34	058.0-W	User 11	HH	0	DVBQ	Auto	11,960,000	30,000,000	Mexico
35	058.0-W	User 12	HH	0	DVBQ	Auto	11,960,000	30,000,000	Mexico
36	058.0-W	User 13	HH	0	DVBQ	Auto	11,960,000	30,000,000	Mexico

37	058.0-W	User 14	HH	0	DVBQ	Auto	11,960,000	30,000,000	Mexico
38	058.0-W	User 15	HH	0	DVBQ	Auto	11,960,000	30,000,000	Mexico
39	058.0-W	User 16	HH	0	DVBQ	Auto	11,960,000	30,000,000	Mexico
40	058.0-W	User 17	HH	0	DVBQ	Auto	11,960,000	30,000,000	Mexico

### Europe

Sat ID	Satellite Longitude	Satellite Name	Polarity & LO Band	NI D	FEC Mode	FEC Rate	Frequency (KHz)	Symbol Rate(KHz)	Beam
41	19.2E	Astra1H	HH	0	DVBQ	Auto	12,692,000	22,000,000	1H
42	28.2E	Astra2A	HH	0	DVBQ	Auto	11,836,000	27,500,000	2A North
43	28.2.0E	Astra2B	HH	0	DVBQ	Auto	12,032,000	27,500,000	2B South
44	30.0W	Hispasat 1C	HH	0	DVBQ	Auto	11,931,000	27,500,000	Europe
45	13.0E	Hotbird9	HH	0	DVBQ	Auto	12,654,000	27,500,000	Europe
46	13.0E	Hotbird8	HH	0	DVBQ	Auto	12,015,000	27,500,000	Europe
47	4.8E	Sirius4	HH	0	DVBQ	Auto	11,919,000	27,500,000	Nordic BSS
48	0.8W	Thor3	HH	0	DVBQ	Auto	12,476,000	28,000,000	Nordic & Central, Eastern Europe
49	26.0E	Bard6	HH	0	DVBQ	Auto	11,843,000	27,500,000	BSS
50	7.0W	Nilesat102	HH	0	DVBQ	Auto	11,996,000	27,500,000	Middle East
51	42.0E	Turksat2A	HH	0	DVBQ	Auto	12,015,000	27,500,000	East
52	7.0E	Eutelsat W3A	HH	0	DVBQ	Auto	12,690,000	2,894,00	Europe B
53	15.8E	Eutelsat Seasat1	HH	0	DVBQ	Auto	12,525,000	30,000,00	Fixed
54	10.0E	Eutelsat W2A	HH	0	DVBQ	Auto	12,522,000	2,893,000	Europe

55	39.0E	Hellasat2	HH	0	DVBQ	Auto	12,524,000	30,000,000	F1
56	5.0W	Atlantic Bird 3	HH	0	DVBQ	Auto	12,543,000	27,500,000	Super
57	4.0W	Amos3	HL	0	DVBQ	Auto	11,389,000	27,500,000	Europe H
58	23.5	Astra2Con	HL	0	DVBQ	Auto	10,803,000	22,000,000	1E H FSS
59	39.0E	Hellasat	HL	0	DVBQ	Auto	10,983,600	8,052,000	F2
60	39.0E	Ipcopter	HL	0	DVBQ	Auto	11,514,000	3,000,000	F2

### Asia

Sat ID	Satellite Longitude	Satellite Name	Polarity & LO Band	NI D	FEC Mode	FEC Rate	Frequency (KHz)	Symbol Rate(KHz)	Beam
61	113.0E	KOR3	HH	0	DVBQ	Auto	11,747,000	21,300,000	South Korea
62	110.0E	N-Sat 110	LH	0	DVBQ	Auto	12,551,000	29,915,000	Japan
63	75.0E	ABS1	HH	0	DVBQ	Auto	12,579,000	22,000,000	South
64	128.0E	JCSAT3A	HH	0	DVBQ	Auto	12,408,000	21,096,000	
65	124.0E	JCSAT4A	HH	0	DVBQ	Auto	12,432,000	21,096,000	Japan
66	166.0E	Intelsat8	HH	0	DVBQ	Auto	12,462,000	2,222,000	NE Asia
67	144.0E	Superbird C2	VH	0	DVBQ	Auto	12,508,000	21,096,000	Japan
68	95.0E	NSS6	HH	0	DVBQ	Auto	12,647,000	27,500,000	India
69	156.0E	Optus C1	HH	0	DVBQ	Auto	12,689,000	27,800,000	NB
70	160.0E	Optus D1	HH	0	DVBQ	Auto	12,613,000	14,294,000	NB
71	152.0E	Optus D2	HH	0	DVBQ	Auto	12,644,000	22,500,000	NANZ
72	95.0E	NSS6	HH	0	DVBQ	Auto	12,729,000	26,400,00	NE Asia
73	95.0E	NSS6	HL	0	DVBQ	Auto	11,676,000	27,500,000	SE Asia

74	108.2E	NSS11	HH	0	DVBQ	Auto	12,431,000	30,000,000	NE Asia
75	88.0E	ST1	HH	0	DVBQ	Auto	12,642,000	24,000,000	K1
76	78.5E	Thaicom5	HH	0	DVBQ	Auto	12,720,000	30,000,000	Thailand
77	146.0E	ABS5	HH	0	DVBQ	Auto	12,581,000	25,600,000	Ku
78	91.5E	Measat3	HH	0	DVBQ	Auto	12,523,000	27,500,000	South Asia
79	105.5E	Asiasat 3S	VH	0	DVBQ	Auto	12,683,000	5,800,000	South Asia
80	132.0E	Vinasat1	H	0	DVBQ	Auto	11,090,000	28,125,000	Ku

## Appendix E: Radome and Antenna Mounting Holes Layout

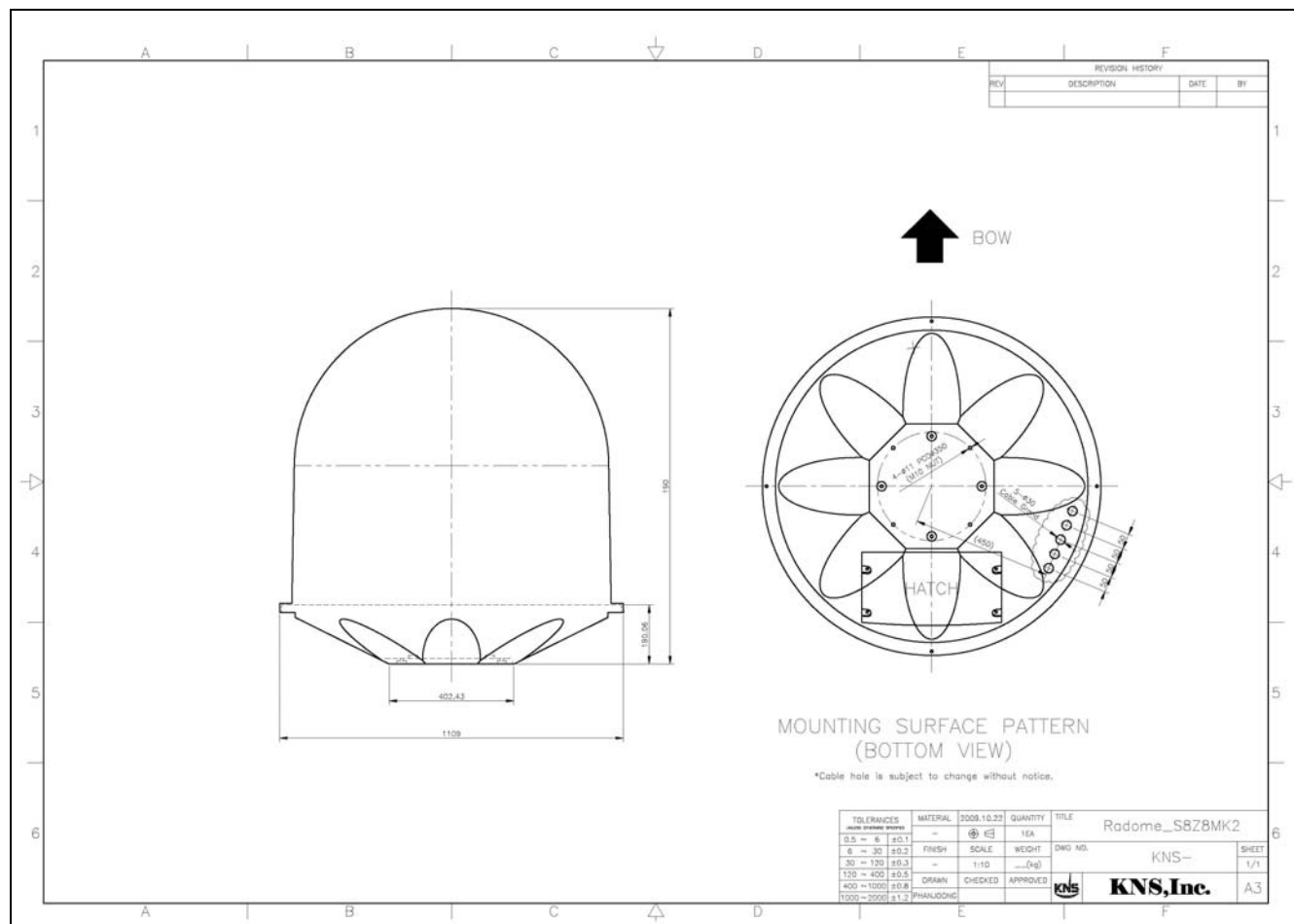

Figure E-1 S8 FRP Radome Layout